

SONY®

4-149-134-11 (1)

α

Preparing the camera

Before your operation

Shooting images

Using the shooting
function

Using the viewing
function

Using the menu

Viewing images on a
computer

Printing images

Additional information on this product and answers to frequently asked questions can be found at our Customer Support Website.

<http://www.sony.net/>

Printed on 70% or more recycled paper using VOC (Volatile Organic Compound)-free vegetable oil based ink.

Printed in Japan



4149134110

α850

Digital Single Lens Reflex Camera
Instruction Manual

DSLR-A850



© 2009 Sony Corporation

Owner's Record

The model and serial numbers are located on the bottom.

Record the serial number in the space provided below.

Refer to these numbers whenever you call upon your Sony dealer regarding this product.

Model No. DSLR-A850

Serial No. _____

WARNING

To reduce fire or shock hazard, do not expose the unit to rain or moisture.

For Customers in the U.S.A.



This symbol is intended to alert the user to the presence of uninsulated “dangerous voltage” within the product's enclosure that may be of sufficient magnitude to constitute a risk of electric shock to persons.



This symbol is intended to alert the user to the presence of important operating and maintenance (servicing) instructions in the literature accompanying the appliance.

IMPORTANT SAFEGUARDS

For your protection, please read these safety instructions completely before operating the appliance, and keep this manual for future reference.

Carefully observe all warnings, precautions and instructions on the appliance, or the one described in the operating instructions and adhere to them.

Use

Power Sources

This set should be operated only from the type of power source indicated on the marking label. If you are not sure of the type of electrical power supplied to your home, consult your dealer or local power company. For those sets designed to operate from battery power, or other sources, refer to the operating instructions.

Polarization

This set may be equipped with a polarized ac power cord plug (a plug having one blade wider than the other).

This plug will fit into the power outlet only one way. This is a safety feature. If you are unable to insert the plug fully into the outlet, try reversing the plug. If the plug should still fail to fit, contact your electrician to have a suitable outlet installed. Do not defeat the safety purpose of the polarized plug by forcing it in.

Overloading

Do not overload wall outlets, extension cords or convenience receptacles beyond their capacity, since this can result in fire or electric shock.

Object and Liquid Entry

Never push objects of any kind into the set through openings as they may touch dangerous voltage points or short out parts that could result in a fire or electric shock. Never spill liquid of any kind on the set.

Attachments

Do not use attachments not recommended by the manufacturer, as they may cause hazards.

Cleaning

Unplug the set from the wall outlet before cleaning or polishing it. Do not use liquid cleaners or aerosol cleaners. Use a cloth lightly dampened with water for cleaning the exterior of the set.

Installation

Water and Moisture

Do not use power-line operated sets near water – for example, near a bathtub, washbowl, kitchen sink, or laundry tub, in a wet basement, or near a swimming pool, etc.

Power-Cord Protection

Route the power cord so that it is not likely to be walked on or pinched by items placed upon or against them, paying particular attention to the plugs, receptacles, and the point where the cord exits from the appliance.

Accessories

Do not place the set on an unstable cart, stand, tripod, bracket, or table. The set may fall, causing serious injury to a child or an adult, and serious damage to the set. Use only a cart, stand, tripod, bracket, or table recommended by the manufacturer.

Ventilation

The slots and openings in the cabinet are provided for necessary ventilation. To ensure reliable operation of the set, and to protect it from overheating, these slots and openings must never be blocked or covered.

– Never cover the slots and openings with a cloth or other materials.

- Never block the slots and openings by placing the set on a bed, sofa, rug, or other similar surface.
- Never place the set in a confined space, such as a bookcase, or built-in cabinet, unless proper ventilation is provided.
- Do not place the set near or over a radiator or heat register, or where it is exposed to direct sunlight.

Lightning

For added protection for this set during a lightning storm, or when it is left unattended and unused for long periods of time, unplug it from the wall outlet and disconnect the antenna or cable system. This will prevent damage to the set due to lightning and power-line surges.

Service

Damage Requiring Service

Unplug the set from the wall outlet and refer servicing to qualified service personnel under the following conditions:

- When the power cord or plug is damaged or frayed.
- If liquid has been spilled or objects have fallen into the set.
- If the set has been exposed to rain or water.
- If the set has been subject to excessive shock by being dropped, or the cabinet has been damaged.
- If the set does not operate normally when following the operating instructions. Adjust only those controls that are specified in the operating instructions. Improper adjustment of other controls may result in damage and will often require extensive work by a qualified technician to restore the set to normal operation.
- When the set exhibits a distinct change in performance – this indicates a need for service.

Servicing

Do not attempt to service the set yourself as opening or removing covers may expose you to dangerous voltage or other hazards.

Refer all servicing to qualified service personnel.

Replacement parts

When replacement parts are required, be sure the service technician has used replacement parts specified by the manufacturer that have the same characteristics as the original parts. Unauthorized substitutions may result in fire, electric shock, or other hazards.

Safety Check

Upon completion of any service or repairs to the set, ask the service technician to perform routine safety checks (as specified by the manufacturer) to determine that the set is in safe operating condition.

**IMPORTANT SAFETY INSTRUCTIONS
SAVE THESE INSTRUCTIONS.
DANGER - TO REDUCE THE RISK OF FIRE OR ELECTRIC SHOCK, CAREFULLY FOLLOW THESE INSTRUCTIONS.**

For connection to a supply not in the U.S.A., use an attachment plug adapter of the proper configuration for the power outlet.

Read this first

CAUTION

Replace the battery with the specified type only. Otherwise, fire or injury may result. Do not expose the batteries to excessive heat such as sunshine, fire or the like.

For Customers in the U.S.A. and Canada

RECYCLING LITHIUM-ION BATTERIES

Lithium-Ion batteries are recyclable.

You can help preserve our environment by returning your used rechargeable batteries to the collection and recycling location nearest you.



For more information regarding recycling of rechargeable batteries, call toll free 1-800-822-8837, or visit <http://www.rbrcl.org/>

Caution: Do not handle damaged or leaking Lithium-Ion batteries.

Battery pack

This device complies with Part 15 of the FCC Rules, Operation is subject to the following two conditions:

(1) This device may not cause harmful interference, and (2) this device must accept any interference received, including interference that may cause undesired operation.

This Class B digital apparatus complies with Canadian ICES-003.

Caution

Incorrect use of the battery pack risks explosion, fire, or chemical burn. Comply with the following precautions.

- Do not disassemble.

- Do not crush and do not expose the battery pack to any shock or force such as hammering, dropping or stepping on it.
- Do not short circuit and do not allow metal objects to come into contact with the battery terminals.
- Do not expose to high temperature above 140°F (60°C) such as in direct sunlight in a car parked in the sun.
- Do not incinerate or dispose of in fire.
- Do not handle damaged or leaking lithium ion batteries.
- Be sure to charge the battery with Sony battery charger or the device that can charge the battery.
- Keep the battery pack out of the reach of small children.
- Keep the battery pack dry.
- Replace only with the same or equivalent type recommended by Sony.
- Dispose of used battery promptly according to the instructions.

For Customers in the U.S.A.

UL is an internationally recognized safety organization. This product has received UL Listing.

If you have any questions about this product, you may call:

Sony Customer Information Services
Center
1-800-222-SONY (7669)

The number below is for the FCC related matters only.

Regulatory Information

Declaration of Conformity
Trade Name: SONY
Model No.: DSLR-A850
Responsible Party: Sony Electronics
Inc.
Address: 16530 Via Esprillo,
San Diego, CA 92127 U.S.A.
Telephone No.: 858-942-2230

This device complies with Part 15 of the FCC Rules. Operation is subject to the following two conditions: (1) This device may not cause harmful interference, and (2) this device must accept any interference received, including interference that may cause undesired operation.

CAUTION

You are cautioned that any changes or modifications not expressly approved in this manual could void your authority to operate this equipment.

Note:

This equipment has been tested and found to comply with the limits for a Class B digital device, pursuant to Part 15 of the FCC Rules.

These limits are designed to provide reasonable protection against harmful interference in a residential installation. This equipment generates, uses, and can radiate radio frequency energy and, if not installed and used in accordance with the instructions, may cause harmful interference to radio communications. However, there is no guarantee that interference will not occur in a particular installation. If this equipment does cause harmful interference to radio or television reception, which can be determined by turning the equipment off and on, the user is encouraged to try to correct the interference by one or more of the following measures:

- Reorient or relocate the receiving antenna.
- Increase the separation between the equipment and receiver.
- Connect the equipment into an outlet on a circuit different from that to which the receiver is connected.
- Consult the dealer or an experienced radio/TV technician for help.

The supplied interface cable must be used with the equipment in order to comply with the limits for a digital device pursuant to Subpart B of Part 15 of FCC Rules.

For the State of California, USA only

Perchlorate Material - special handling may apply, See

www.dtsc.ca.gov/hazardouswaste/perchlorate

Perchlorate Material: Lithium battery contains perchlorate.

For Customers in Europe

This product has been tested and found compliant with the limits set out in the EMC Directive for using connection cables shorter than 3 meters (9.8 feet).

Attention

The electromagnetic fields at the specific frequencies may influence the picture and sound of this unit.

Notice

If static electricity or electromagnetism causes data transfer to discontinue midway (fail), restart the application or disconnect and connect the communication cable (USB, etc.) again.

Disposal of Old Electrical & Electronic Equipment (Applicable in the European Union and other European countries with separate collection systems)



This symbol on the product or on its packaging indicates that this product shall not be treated as household waste. Instead it shall be handed over to the applicable collection point for the recycling of electrical and electronic equipment. By ensuring this product is disposed of correctly, you will help prevent potential negative consequences for the environment and human health, which could otherwise be caused by inappropriate waste handling of this product. The recycling of materials will help to conserve natural resources. For more detailed information about recycling of this product, please contact your local Civic Office, your household waste disposal service or the shop where you purchased the product.

Disposal of waste batteries (applicable in the European Union and other European countries with separate collection systems)



This symbol on the battery or on the packaging indicates that the battery provided with this product shall not be treated as household waste.

By ensuring these batteries are disposed of correctly, you will help prevent potentially negative consequences for the environment and human health which could otherwise be caused by inappropriate waste handling of the battery. The recycling of the materials will help to conserve natural resources.

In case of products that for safety, performance or data integrity reasons require a permanent connection with an incorporated battery, this battery should be replaced by qualified service staff only. To ensure that the battery will be treated properly, hand over the product at end-of-life to the applicable collection point for the recycling of electrical and electronic equipment.

For all other batteries, please view the section on how to remove the battery from the product safely. Hand the battery over to the applicable collection point for the recycling of waste batteries.

For more detailed information about recycling of this product or battery, please contact your local Civic Office, your household waste disposal service or the shop where you purchased the product.

Notice for customers in the United Kingdom

A moulded plug complying with BS 1363 is fitted to this equipment for your safety and convenience.

Should the fuse in the plug supplied need to be replaced, a fuse of the same rating as the supplied one and approved by ASTA or BSI to BS 1362, (i.e., marked with an  or  mark) must be used.

If the plug supplied with this equipment has a detachable fuse cover, be sure to attach the fuse cover after you change the fuse.

Never use the plug without the fuse cover.

If you should lose the fuse cover, please contact your nearest Sony service station.

Notice for the customers in the countries applying EU Directives

The manufacturer of this product is Sony Corporation, 1-7-1 Konan Minato-ku Tokyo, 108-0075 Japan. The Authorized Representative for EMC and product safety is Sony Deutschland GmbH, Hedelfinger Strasse 61, 70327 Stuttgart, Germany. For any service or guarantee matters please refer to the addresses given in separate service or guarantee documents.

Notes on using your camera

No compensation for contents of the recording

The contents of the recording cannot be compensated for if recording or playback is not possible due to a malfunction of your camera or a memory card, etc.

Back up recommendation

To avoid the potential risk of data loss, always copy (back up) data to other medium.

Notes on the LCD monitor and lens

- The LCD monitor is manufactured using extremely high-precision technology so over 99.99% of the pixels are operational for effective use. However, there may be some tiny black points and/or bright points (white, red, blue or green in color) that constantly appear on the LCD monitor. These points are normal in the manufacturing process and do not affect the images in any way.

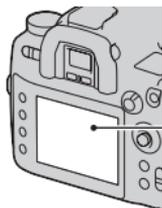

Black, white, red,
blue and green
points

- Do not expose the camera to direct sunlight. If sunlight is focused on a nearby object, it may cause a fire. When you must place the camera under direct sunlight, attach the lens cap.
- Images may trail across on the LCD monitor in a cold location. This is not a malfunction. When turning on the camera in a cold location, the LCD monitor may become temporarily dark. When the camera warms up, the monitor will function normally.
- Do not press against the LCD monitor. The monitor may be discolored and that may cause a malfunction.

Warning on copyright

Television programs, films, videotapes, and other materials may be copyrighted.

Unauthorized recording of such materials may be contrary to the provisions of the copyright laws.

The pictures used in this manual

The photographs used as examples of pictures in this manual are reproduced images, and are not actual images shot using this camera.

Table of Contents

	IMPORTANT SAFEGUARDS.....	3
	Read this first	5
	Notes on using your camera	9
Preparing the camera	Checking the accessories supplied	13
	Preparing the battery pack	14
	Attaching a lens	21
	Inserting a memory card	23
	Preparing the camera	27
	Using the accessories supplied	29
	Checking the number of recordable images	31
	Cleaning	33
Before your operation	Identifying parts and screen indicators	36
	Front side	36
	Rear side	37
	Sides/Bottom	38
	LCD monitor (Recording information display)	39
	Display panel	42
	Viewfinder	43
	Selecting a function/setting	45
	Selecting the functions on the Quick Navi screen	46
Shooting images	AUTO Shooting with the automatic setting	47
	Exposure mode	49
	P Shooting with Program auto	49
	A Shooting with Aperture priority	51
	S Shooting with Shutter speed priority	52
	M Shooting with Manual exposure	53
	M Shooting with BULB	54
Using the shooting function	Selecting the focus method	56
	Selecting the focus mode (Auto focus)	56
	Selecting the focus area	58
	Shooting with focus-lock	59
	AF illuminator	60
	Shooting with Manual focus	60
	Shooting with Direct manual focus	61
	Switching the AF/MF easily	62

Using a flash (sold separately)	63
Selecting the flash mode	64
Shooting with Slow Sync	65
Shooting with High Speed Sync (HSS)	65
Using a flash equipped with a flash sync terminal cord	66
Adjusting the brightness of the image (Metering, Exposure, Flash compensation)	67
Selecting the Metering mode	67
Compensating the exposure	68
Shooting with fixed brightness (AE Lock)	69
Adjusting the amount of flash light (Flash compensation)	71
Setting ISO	72
Adjusting the color tones (White balance)	73
Auto/Preset white balance	73
Setting the color temperature and a filter effect	74
Custom white balance	75
Image processing	77
Using the D-Range Optimizer	77
Using the Creative Style	78
Selecting the drive mode	81
Shooting single shot	81
Shooting continuously	82
Using the self-timer	83
Shooting with Exposure bracket	83
Shooting with the white balance bracket	85
Shooting with the DRO advanced bracket	85
Shooting with the mirror lockup function	85
Shooting with the Wireless Remote Commander	86
Using the preview function	87
Registering your own settings	89
Using the viewing function	
Playing back images	90
Checking the information of recorded images	95
Deleting images (Delete)	97
Viewing images on a TV screen	99

Using the menu	Menu function list	102
	📷 Recording menu 1	104
	📷 Recording menu 2	107
	📷 Recording menu 3	109
	📷 Recording menu 4	111
	⚙ Custom menu 1	113
	⚙ Custom menu 2	115
	⚙ Custom menu 3	118
	▶ Playback menu 1	120
	▶ Playback menu 2	123
	🔧 Setup menu 1	124
	🔧 Setup menu 2	126
	🔧 Setup menu 3	129
	🔧 Setup menu 4	132
Viewing images on a computer	Copying images to your computer	135
	Viewing images on your computer	139
	Using the software	143
Printing images	Printing images by connecting the camera to a PictBridge compliant printer	150
Others	Specifications	154
	Troubleshooting	157
	Warning messages	164
	Precautions	167
Index		169

Checking the accessories supplied

The number in parentheses indicates the number of pieces.

- BC-VM10 Battery charger (1)/
Power cord (mains lead) (1)



- Rechargeable battery pack NP-FM500H (1)



- Remote Commander clip (1)



- USB cable (1)

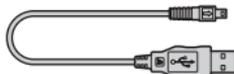

- Video cable (1)



- Shoulder strap (1)

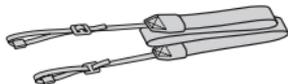

- Body cap (1) (Attached on the camera)



- Accessory shoe cap (1) (Attached on the camera)
- Eyecup (1) (Attached on the camera)
- CD-ROM (Application Software for α camera) (1)
- Instruction Manual (This manual) (1)

Preparing the battery pack

When using the camera for the first time, be sure to charge the NP-FM500H “InfoLITHIUM” battery pack (supplied).

Charging the battery pack

The “InfoLITHIUM” battery pack can be charged even when it has not been fully depleted.

It can also be used when it has not been fully charged.

1 Insert the battery pack on the battery charger.

Push the battery pack until it clicks.

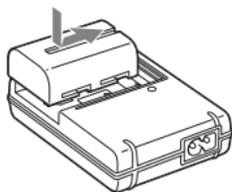

2 Connect the power cord (mains lead).

Light on: Charging

Light off: Normal charge completed

One hour after the lamp is turned off: Full charge completed

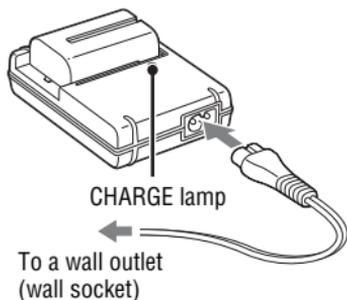

About charging time

- Time required to charge a fully depleted battery pack (supplied) at a temperature of 25°C (77°F) is as follows.

Full charge	Normal charge
Approx. 235 min.	Approx. 175 min.

- The charging time differs depending on the remaining capacity of the battery back or charging conditions.

- We recommend charging the battery pack in an ambient temperature of between 10 to 30°C (50 to 86°F). You may not be able to efficiently charge the battery pack outside of this temperature range.

Notes

- Connect the battery charger to an easily accessible wall outlet (wall socket) close by.
- Even if the CHARGE lamp is not lit, the battery charger is not disconnected from the AC power source (mains) as long as it is connected to the wall outlet (wall socket). If some trouble occurs while using the battery charger, immediately shut off the power by disconnecting the plug from the wall outlet (wall socket).
- When charging is finished, disconnect the power cord (mains lead) from the wall outlet (wall socket), and remove the battery pack from the battery charger. If you leave the charged battery pack on the charger, battery life may be decreased.
- Do not charge any battery pack other than the “InfoLITHIUM” M series battery pack in the battery charger (supplied) with your camera. Batteries other than the specified kind may leak, overheat, or explode if you attempt to charge them, posing a risk of injury from electrocution and burns.
- When the CHARGE lamp flashes, this may indicate a battery error or that a battery pack other than the specified type has been installed. Check that the battery pack is the specified type. If the battery pack is the specified type, remove the battery pack, replace it with new one or another one and check if the battery charger operates correctly. If the battery charger operates correctly, a battery error may have occurred.
- If the battery charger is dirty, charging may not be performed successfully. Clean the battery charger with dry cloth, etc.

To use your camera abroad — Power sources

You can use your camera and the battery charger and the AC-VQ900AM AC Adaptor/charger (sold separately) in any country or region where the power supply is within 100 V to 240 V AC, 50/60 Hz. Use a commercially available AC plug adaptor [a], if necessary, depending on the design of the wall outlet (wall socket) [b].

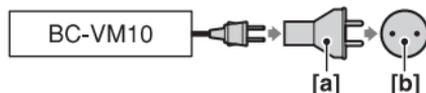

Note

- Do not use an electronic transformer (travel converter), as this may cause a malfunction.

Representative plug of power supply cord of countries/regions around the world.

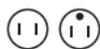

A Type
(American
Type)



B Type
(British
Type)



BF Type
(British
Type)



B3 Type
(British
Type)



C Type
(CEE
Type)



SE Type
(CEE
Type)



O Type
(Ocean
Type)

The representative supply voltage and plug type are described in this chart.

Depend on an area, Different type of plug and supply voltage are used.

Attention: Power cord meeting demands from each country shall be used.

-For only the United States

Use a UL Listed, 1.5-3 m (5-10 ft.), Type SPT-2 or NISPT-2, AWG no. 18 power supply cord, rated for 125 V 7 A, with a non-polarized NEMA 1-15P plug rated for 125 V 15 A.”

Europe

Countries/regions	Voltage	Frequency (Hz)	Plug type
Austria	230	50	C
Belgium	230	50	C
Czech	220	50	C
Denmark	230	50	C
Finland	230	50	C
France	230	50	C
Germany	230	50	C
Greece	220	50	C
Hungary	220	50	C
Iceland	230	50	C
Ireland	230	50	C/BF
Italy	220	50	C
Luxemburg	230	50	C
Netherlands	230	50	C
Norway	230	50	C
Poland	220	50	C
Portugal	230	50	C
Romania	220	50	C
Russia	220	50	C
Slovak	220	50	C
Spain	127/230	50	C
Sweden	230	50	C
Switzerland	230	50	C
UK	240	50	BF

Asia

Countries/regions	Voltage	Frequency (Hz)	Plug type
China	220	50	A
Hong Kong	200/220	50	BF
India	230/240	50	C
Indonesia	127/230	50	C
Japan	100	50/60	A
Korea (rep)	220	60	C
Malaysia	240	50	BF
Philippines	220/230	60	A/C

Singapore	230	50	BF
Taiwan	110	60	A
Thailand	220	50	C/BF
Vietnam	220	50	A/C

Oceania

Countries/regions	Voltage	Frequency (Hz)	Plug type
Australia	240	50	O
New Zealand	230/240	50	O

North America

Countries/regions	Voltage	Frequency (Hz)	Plug type
Canada	120	60	A
USA	120	60	A

Central America

Countries/regions	Voltage	Frequency (Hz)	Plug type
Bahamas	120/240	60	A
Costa Rica	110	60	A
Cuba	110/220	60	A/C
Dominican (rep)	110	60	A
El Salvador	110	60	A
Guatemala	120	60	A
Honduras	110	60	A
Jamaica	110	50	A
Mexico	120/127	60	A
Nicaragua	120/240	60	A
Panama	110/220	60	A

South America

Countries/regions	Voltage	Frequency (Hz)	Plug type
Argentina	220	50	C/BF/O
Brazil	127/220	60	A/C
Chile	220	50	C
Colombia	120	60	A
Peru	220	60	A/C
Venezuela	120	60	A

Middle East

Countries/regions	Voltage	Frequency (Hz)	Plug type
Iran	220	50	C/BF
Iraq	220	50	C/BF
Israel	230	50	C
Saudi Arabia	127/220	50	A/C/BF
Turkey	220	50	C
UAE	240	50	C/BF

Africa

Countries/regions	Voltage	Frequency (Hz)	Plug type
Algeria	127/220	50	C
Congo (dem)	220	50	C
Egypt	220	50	C
Ethiopia	220	50	C
Kenya	240	50	C/BF
Nigeria	230	50	C/BF
South Africa	220/230	50	C/BF
Tanzania	230	50	C/BF
Tunisia	220	50	C

Inserting the charged battery pack

- 1** While sliding the battery cover open lever, open the battery cover.

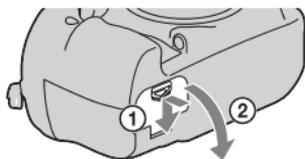

- 2** Firmly insert the battery pack all the way while pressing the lock lever with the tip of the battery.

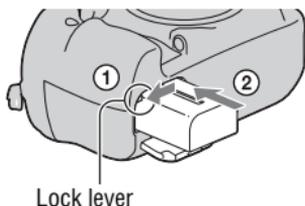

- 3** Close the battery cover.

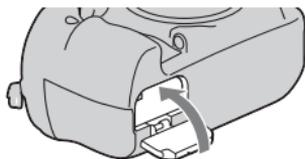

To remove the battery pack

Turn off the camera and slide the lock lever in the direction of the arrow. Be careful not to drop the battery pack.

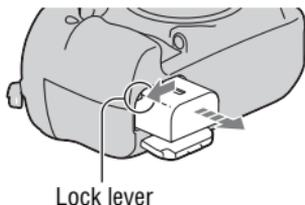

To check the remaining battery level

Set the power switch to ON and check the level on the LCD monitor. The level is indicated with the percent figures, in addition to the following indicators.

Battery level						“Battery exhausted”
	High Low					You cannot shoot any more pictures.

What is an “InfoLITHIUM” battery pack?

An “InfoLITHIUM” battery pack is a lithium-ion battery pack that has functions for exchanging information related to operating conditions with your camera. Using the “InfoLITHIUM” battery pack, the remaining battery time in percent figures is displayed according to the operating conditions of your camera.

Notes

- The displayed level may not be correct under certain circumstances.
- Do not expose the battery pack to water. The battery pack is not water-resistant.
- Do not leave the battery pack in extremely hot places, such as in a car or under direct sunlight.

Available battery packs

Use only an NP-FM500H battery pack. Note that the NP-FM55H, NP-FM50 and NP-FM30 cannot be used.

The number of images that can be recorded

The approximate number of images that can be recorded is 880 when you use the camera with the battery pack at full capacity.

Note that the actual numbers may be less than those indicated depending on the conditions of use, the attached lens, or the memory card.

- The number is calculated with a battery pack at full capacity and in the following situation:
 - At an ambient temperature of 25°C (77°F).
 - [Quality] is set to [Fine].
 - Focus mode is set to AF-A (Automatic AF).
 - Shooting once every 30 seconds.
 - The power turns on and off once every ten times.

- The measurement method is based on the CIPA standard. (CIPA: Camera & Imaging Products Association)
- The battery capacity decreases as the number of uses increases and also over time.
- The number of images that can be recorded is decreased under the following conditions:
 - The surrounding temperature is low.
 - The camera has been turned on and off many times.
 - Focus mode is set to AF-C (Continuous AF).
 - When the camera continues to focus for a long time without shooting, including cases where you press and hold the shutter button halfway down.

Effective use of the battery pack

Battery performance decreases in low temperature surroundings. So, the time that the battery pack can be used is shorter in cold places. We recommend the following to ensure longer battery pack use: put the battery pack in a pocket close to your body to warm it up, and insert it in your camera immediately before you start shooting.

Battery life

- The battery life is limited. Battery capacity decreases little by little as you use it more and more, and as time passes. If the battery operating time seems shortened considerably, a probable cause is that the battery pack has reached the end of its life. Buy a new battery pack.
- The battery life varies according to how it is stored and the operating conditions and environment in which each battery pack is used.

How to store the battery pack

If the battery pack is not to be used for a long time, fully charge it and then fully use it up once a year on your camera before storing the battery pack in a dry, cool place to prolong the battery life.

Attaching a lens

1 Remove the body cap from the camera and the rear cap from the lens.

2 Mount the lens by aligning the orange index marks on the lens and camera.

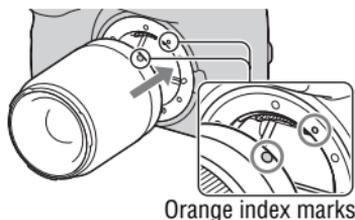

3 Turn the lens clockwise until it clicks into the locked position.

- When attaching a lens, do not press the lens release button.
- Be sure to put the lens on straight.



Notes

- The shutter is not released if the lens is not attached, except when the mode dial is set to M (page 53).
- Using a DT lens is not guaranteed because the corners of the field are darkened and the camera does not meet the primary AE performance standard.

To remove the lens

1 Press the lens release button all the way in and turn the lens counterclockwise until it stops.

- When changing the lens, quickly change the lens away from dusty locations so as to keep dust from getting inside the camera.

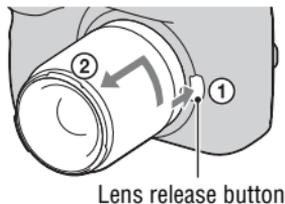

2 Replace the cap on the lens and attach the body cap to the camera.

- Before you attach the cap, remove dust from the cap.
-

Note on changing the lens

The camera is equipped with an anti-dust function to prevent dust from landing on the image sensor. However, quickly change the lens away from dusty locations to keep dust or debris from getting inside the camera when attaching/removing a lens.

If dust or debris lands on the image sensor

Clean the image sensor using [Cleaning mode] in the  Setup menu (page 34).

Inserting a memory card

You can use a CompactFlash card (CF card), Microdrive, or “Memory Stick Duo” media as a memory card.

1 Open the memory card cover.

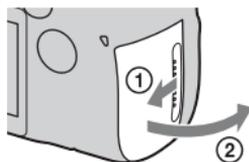

2 Insert a memory card (sold separately) from the terminal part (the terminal side has a number of small holes).

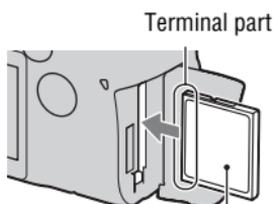

Set the face side with the label toward the LCD monitor.

- For “Memory Stick Duo” media, insert it all the way in until it clicks.

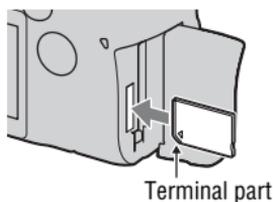

3 Close the memory card cover.

Note

- In the default setting, a CF card is selected as the memory card. If you use “Memory Stick Duo” media, you have to switch the memory card setting (page 24).

Notes on using memory cards

- The memory card may be hot just after it has been used for a long time. Be careful when you handle it.
- When the access lamp is lit, do not remove the memory card or the battery pack, or turn off the power. The data may be corrupted.
- Data may be damaged if you place the memory card near strongly-magnetized material or use the memory card in a static-prone or electrically noisy environment.
- We recommend backing up important data, such as to a hard disk of a computer.
- When you carry or store the memory card, put it in the case supplied with it.
- Do not expose the memory card to water.
- Do not touch the terminal section of the memory card with your hand or a metal object.

On the CF card/Microdrive

- Be sure to format the CF card/Microdrive using this camera when you use it for the first time.
- Do not remove the label of a CF card/Microdrive or attach a new label over the label.
- Do not press on the label strongly.

On the “Memory Stick” media

- “Memory Stick Duo” media: You can use the “Memory Stick Duo” media with your camera.

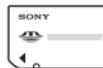

- “Memory Stick” media: You cannot use the “Memory Stick” media with your camera.



- “Memory Stick PRO Duo” media or “Memory Stick PRO-HG Duo” media with a capacity up to 16 GB have been confirmed to operate properly with this camera.

- “Memory Stick Duo” media formatted with a computer is not guaranteed to operate with this camera.
- Data read/write speeds differ depending on the combination of the “Memory Stick Duo” media and the equipment used.

Notes on using “Memory Stick Duo” media

- Do not press down hard when you write down on the memo area.
- Do not attach a label on the “Memory Stick Duo” media itself.
- Do not strike, bend or drop the “Memory Stick Duo” media.
- Do not disassemble or modify the “Memory Stick Duo” media.
- Do not leave the “Memory Stick Duo” media within the reach of small children. They might accidentally swallow it.
- Do not use or store the “Memory Stick Duo” media under the following conditions:
 - High temperature locations such as the hot interior of a car parked in direct sunlight.
 - Locations exposed to direct sunlight.
 - Humid locations or locations with corrosive substances present.

Preparing the camera

Setting up the date

When you turn the camera on for the first time, the date/time setup screen appears.

1 Set the power switch to ON to turn the camera on.

- To turn the camera off, set it to OFF.

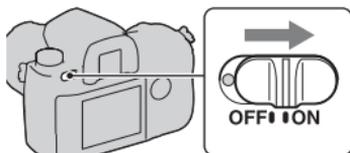

2 Verify that [OK] is selected on the LCD monitor, then press the center of the multi-selector.

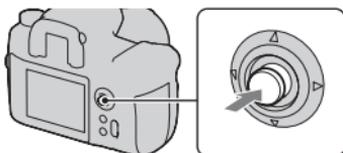

3 Select each item with ◀/▶ and set the numeric value with ▲/▼.

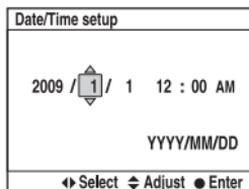
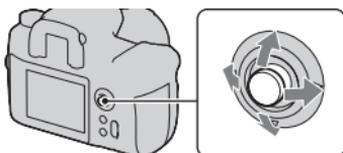

4 Repeat step 3 to set other items, then press the center of the multi-selector.

- When changing the sequence of [YYYY/MM/DD], first select [YYYY/MM/DD] with ◀/▶, then change it with ▲/▼.

5 Verify that [OK] is selected, then press the center of the multi-selector.

To cancel the date/time setting operation

Press the MENU button.

Adjusting the diopter

Adjust the diopter-adjustment dial to your eyesight until the indicators appear clearly in the viewfinder.

- Turn the dial toward + when you are far-sighted, toward – when you are near-sighted.
- Training the camera on the light allows you to adjust the diopter easily.

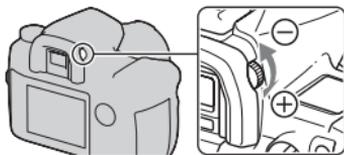

When it is hard to rotate the diopter-adjustment dial

Insert your fingers under the eyecup, and slide it upward to remove the eyecup, then adjust the diopter.

- When attaching the FDA-M1AM Magnifier (sold separately) or the FDA-A1AM Angle Finder (sold separately) to the camera, remove the eyecup as illustrated and attach them.

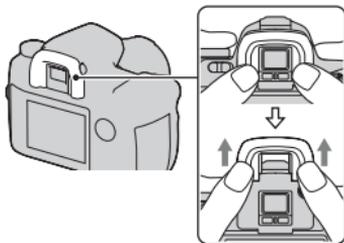

Using the accessories supplied

This section describes how to use the shoulder strap and Remote Commander clip. The other accessories are described in the following pages.

- Rechargeable battery pack (page 14)
- Battery charger, Power cord (mains lead) (page 14)
- Eyecup (page 28)
- USB cable (pages 101, 136, 151)
- Video cable (page 99)
- CD-ROM (page 144)

Attaching the shoulder strap

Attach the both ends of the strap on the camera.

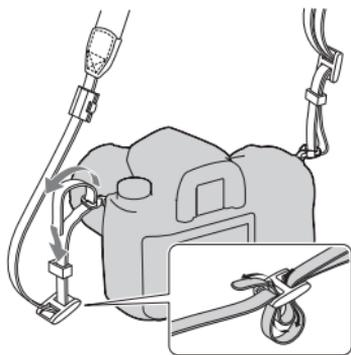

Using the Remote Commander clip

You can catch the cord of the RM-S1AM Remote Commander (sold separately) on the shoulder strap to secure it.

1 Open the Remote Commander clip.



2 Clip the strap and the cord of the Remote Commander to the Remote Commander clip.



3 Close the Remote Commander clip.



Checking the number of recordable images

Once you insert a memory card into the camera and set the power switch to ON, the number of images that can be recorded (should you continue to shoot using the current settings) is displayed on the LCD monitor.

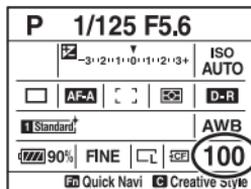

Notes

- If “0” flashes in yellow, the memory card is full. Replace the memory card with another one, or delete images in the current memory card (page 97).
- When “----” flashes in yellow, it means no memory card is inserted or [Memory card] (page 126) is not set to a correct position. Insert a memory card or set it to a correct position.

The number of images that can be recorded on a memory card

The tables show the approximate number of images that can be recorded on a memory card formatted with this camera. The values may vary depending on the shooting conditions.

The number of recordable images (Units: Images)

Image size: L 24M/Aspect ratio: 3:2*

CF card

Quality \ Capacity	1GB	2GB	4GB	8GB	16GB
Standard	148	296	593	1185	2370
Fine	98	197	395	790	1580
Extra fine	43	86	172	343	687
cRAW & JPEG	28	56	112	224	449
RAW & JPEG	20	41	83	166	333
cRAW	39	78	157	313	627
RAW	26	52	105	211	423

“Memory Stick Duo” media

Quality \ Capacity	1GB	2GB	4GB	8GB	16GB
Standard	145	294	582	1169	2369
Fine	97	196	388	779	1579
Extra fine	42	85	168	339	687
cRAW & JPEG	27	55	110	221	449
RAW & JPEG	20	41	81	164	333
cRAW	38	77	154	309	627
RAW	26	52	103	208	423

* When [Aspect ratio] is set to [16:9], you can record more images than the numbers shown in the tables above. However, if you record an image as a RAW image, the number is the same as that of the [3:2] aspect ratio.

Cleaning

Cleaning the LCD monitor

Wipe the screen surface with an LCD cleaning kit (sold separately) to remove fingerprints, dust, etc.

Cleaning the lens

- When cleaning the lens surface, remove dust using a blower. In case of dust that sticks to the surface, wipe it off with a soft cloth or tissue paper slightly moistened with lens cleaning solution. Wipe in a spiral pattern from the center to the outside. Do not spray lens cleaning solution directly onto the lens surface.
- Do not touch the inside of the camera, such as lens contacts, or the mirror. Since dust on the mirror or around the mirror may affect the auto focus system, blow away dust using a commercially available blower. If dust lands on the image sensor, it may appear on the photo image. Turn the camera to the cleaning mode, then clean it using a blower (page 34). Do not use a spray blower to clean the inside of the camera. Using this may cause a malfunction.
- Do not use a cleaning solution containing organic solvents, such as thinner, or benzine.

Cleaning the camera surface

Clean the camera surface with a soft cloth slightly moistened with water, then wipe the surface with a dry cloth. Do not use the following as they may damage the finish or the casing.

- Chemical products such as thinner, benzine, alcohol, disposable cloths, insect repellent, sunscreen or insecticide, etc.
- Do not touch the camera with the above on your hand.
- Do not leave the camera in contact with rubber or vinyl for a long time.

Cleaning the image sensor

If dust or debris enters the camera and lands on the image sensor, it may appear on the photo image, depending on the shooting environment. If there is dust on the image sensor, use a commercially available blower and clean the image sensor following the steps below. You can easily clean the image sensor using only the blower and the anti-dust function.

Notes

- Cleaning can be performed only when the battery level is  (three remaining battery icons) or more. Low battery power during cleaning can cause damage to the shutter. The cleaning should be completed quickly. The use of an AC Adaptor/Charger (sold separately) is recommended.
- Do not use a spray blower because it may scatter vapor inside the camera body.

1 Confirm that the battery is fully charged (page 19).

2 Press the MENU button, then select  3 with /  on the multi-selector.

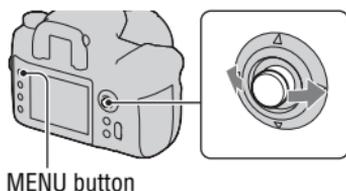

3 Select [Cleaning mode] with /  on the multi-selector, then press the center of the multi-selector.

The message “After cleaning, turn camera off. Continue?” appears.

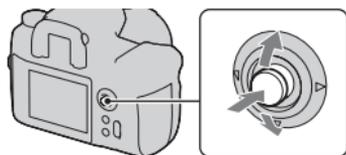

4 Select [OK] with  on the multi-selector, and press the center of the multi-selector.

After the image sensor vibrates for a short time, the mirror in front is lifted.

5 Detach the lens (page 21).

6 Use the blower to clean the image sensor surface and the surrounding area.

- Do not touch the image sensor with the tip of the blower. Complete the cleaning quickly.
- Hold the camera's face downward to prevent the dust from resettling in the camera.
- When cleaning the image sensor, do not put the tip of a blower into the cavity beyond the mount.

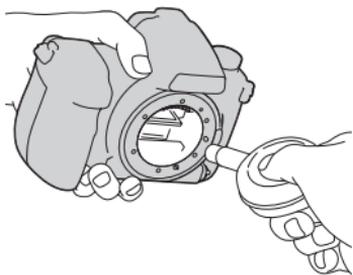

7 Attach the lens and turn the camera off.

Note

- The camera starts beeping if the battery pack is discharged during cleaning. Stop the cleaning immediately and turn the camera off.

Identifying parts and screen indicators

See the pages in parentheses for details of operation.

Front side

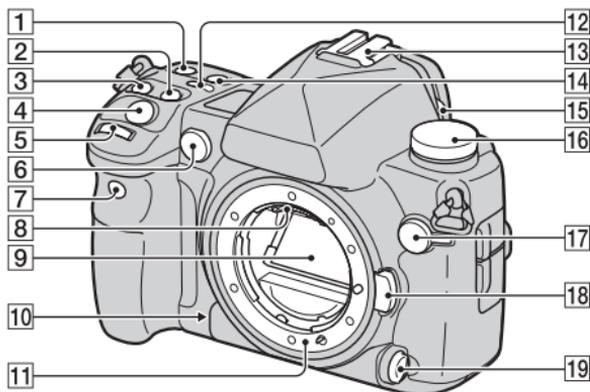

- | | |
|---|--|
| 1 ISO button (72) | 13 Accessory shoe (63) |
| 2  (Exposure) button (68) | 14 WB (White Balance) button (73) |
| 3 DRIVE button (81) | 15 Eyepiece shutter lever (83, 86, 148) |
| 4 Shutter button (47) | 16 Mode dial (47, 49, 89) |
| 5 Front control dial (46, 115) | 17  (Flash sync) terminal (66) |
| 6 AF illuminator (60)/Self-timer lamp (83) | 18 Lens release button (21) |
| 7 Remote sensor (86) | 19 Focus mode lever (56, 60) |
| 8 Lens contacts* | |
| 9 Mirror* | |
| 10 Preview button (87) | |
| 11 Lens mount | |
| 12  (Display panel illumination) button (42) | |

* **Do not directly touch these parts.**

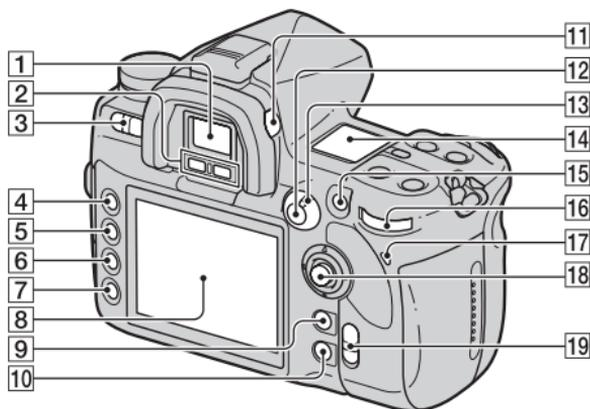

- | | |
|--|---|
| <p>1 Viewfinder (28)</p> <p>2 Eyepiece sensors (124)</p> <p>3 Power switch (27)</p> <p>4 MENU button (102)</p> <p>5 DISP (Display) button/LCD brightness button (40, 90)</p> <p>6  (Delete) button (97)</p> <p>7  (Playback) button (90)</p> <p>8 LCD monitor (39)</p> <p>9 For shooting: C (Custom) button (106)
For viewing:  (Histogram) button (91)</p> <p>10 For shooting: Fn (Function) button (46)
For viewing:  (Image rotation) button (92)</p> | <p>11 Diopter-adjustment dial (28)</p> <p>12 For shooting: AEL (AE lock) button (69)/SLOW SYNC button (65)
For viewing:  (Index) button (94)</p> <p>13 Metering mode lever (67)</p> <p>14 Display panel (42)</p> <p>15 For shooting: AF/MF (Auto focus/manual focus) button (62)
For viewing:  (Enlarge) button (93)</p> <p>16 Rear control dial (46, 115)</p> <p>17 Access lamp (24)</p> <p>18 Multi-selector (45)</p> <p>19  (SteadyShot) switch (44)</p> |
|--|---|

Sides/Bottom

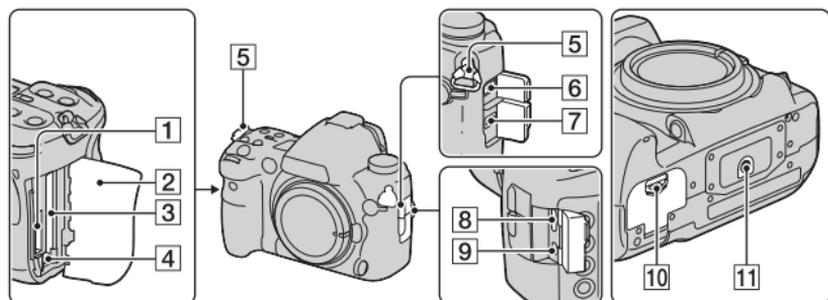

- 1 “Memory Stick Duo” media insertion slot (23)
- 2 Memory card cover (23)
- 3 CF card insertion slot (23)
- 4 CF card eject lever (24)
- 5 Hooks for shoulder strap (29)

- 6 REMOTE terminal
- 7 DC IN terminal

- When connecting the AC-VQ900AM AC Adaptor/Charger (sold separately) to the camera, turn the camera off, then plug the connector of the AC Adaptor/Charger to the DC IN terminal on the camera.

- 8 HDMI terminal (101)
- 9 VIDEO OUT/ (USB) terminal (99, 136)
- 10 Battery cover (18)

- 11 Tripod receptacle

- Use a tripod with a screw length of less than 5.5 mm (7/32 inch). You will be unable to firmly secure the camera to tripods having screws longer than 5.5 mm (7/32 inch), and may damage the camera.

LCD monitor (Recording information display)

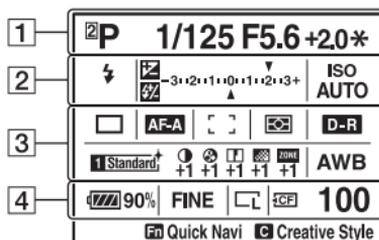

- The illustration above is an example of the detailed display in the horizontal position.

1

Display	Indication
AUTO P A S M 1 2 3	Mode dial (47, 49)
1/125	Shutter speed (52)
F5.6	Aperture (51)
+2.0	Exposure (68)
*	AE lock (69)

2

Display	Indication
	Flash mode (63)
	Exposure compensation (68)/Metered Manual (53)
	Flash compensation (71)
	EV scale (53, 84)
ISO AUTO	ISO sensitivity (72)

3

Display	Indication
	Drive mode (81)
	Focus mode (56)
	AF area (58)
	Metering (67)
	D-Range Optimizer (77)
	Creative Style (78)
	Contrast, Saturation, Sharpness, Brightness, Zone (80)

Display	Indication
AWB	White balance (Auto, Preset, Color temperature, Color filter, Custom) (73)
WB 5500K	
M1	

4

Display	Indication
90%	Battery remaining (19)
RAW cRAW RAW+J cRAW+J X.FINE FINE STD	Image quality (105)
 	Image size (104)/APS-C size (132)/Aspect ratio (104)
	Memory card (24)
100	Remaining number of recordable images (31)

Switching the recording information display

Press the DISP button to switch between the enlarged display and the detailed display.

When you rotate the camera to a vertical position, the display automatically rotates to adjust to the camera position.

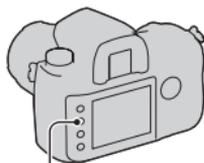

DISP button

Detailed display

P	1/125	F5.6	+0.3
	ISO	AUTO	
	AWB		
90%	FINE		100
		Creative Style	

Enlarged display

P	1/125	F5.6	
	+0.3	ISO	AUTO
			AWB
90%	FINE		100
		Creative Style	

No display



- You can set the display so as not to be rotated with [Rec.info.disp.] in the Custom menu (page 117).

Note

- You can display the screen used for adjusting the brightness of the LCD monitor by pressing the DISP button a little longer (page 124).

Display panel

You can adjust white balance, ISO sensitivity, drive mode, and exposure compensation by checking the display panel on the top of the camera.

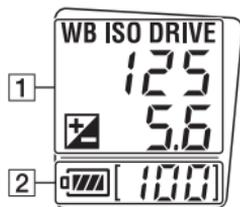

1

Shutter speed (52)/Aperture (51)	Exposure (68)	White balance (73)	ISO sensitivity (72)	Drive mode (81)

2

Display	Indication
	Battery remaining (19)
[100]	Remaining number of recordable images (31)*

* Even when the remaining number of recordable images is more than 999, “999” is displayed on the display panel.

To turn on the backlight of the display panel

Press the display panel illumination button on the top. Pressing again turns off the backlight.

Display panel illumination button

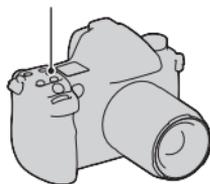

Viewfinder

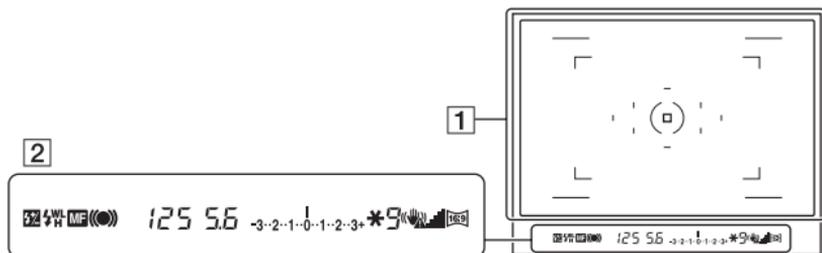

1

Display	Indication
	AF area (58)
	Spot AF area (58)
	Spot metering area (67)
	Shooting area for aspect ratio 16:9 (104)
	APS-C size area (132)

Display	Indication
	SteadyShot scale (44)
	Aspect ratio 16:9 (104)

2

Display	Indication
	Flash compensation (71)
	Flash charging (63)
WL	Wireless flash (64)
H	High-speed sync (65)
MF	Manual focus (60)
	Focus (57)
125	Shutter speed (52)
5.6	Aperture (51)
-3 -2 -1 0 1 2 3+	EV scale (53, 84)
*	AE lock (69)
9	Shots-remaining counter (82)
	Camera shake warning (44)

Camera shake warning indicator

Due to potential camera shake, the  (Camera shake warning) indicator flashes in the viewfinder.

Note

- The  (Camera shake warning) indicator is displayed only in the exposure modes that the shutter speed is automatically set. This indicator is not displayed in M/S/P_S modes.

SteadyShot scale indicator

Setting the  switch to “ON” turns on the  (SteadyShot scale) indicator. Wait until the camera shake is reduced and the scale becomes low, then start shooting. This SteadyShot function can reduce the effect of camera shake by the equivalent of approximately 2.5 to 4 increments of shutter speed.

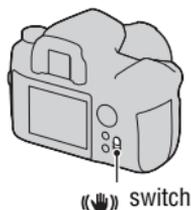

Note

- The SteadyShot function may not work optimally when the power has just been turned on, just after you aim the camera, or when the shutter button has been pressed all the way down without stopping halfway. Wait for the  (SteadyShot scale) indicator scale to go down, and then press the shutter button down slowly.

Selecting a function/setting

You can select a function for shooting or playback on the recording information display that is displayed by pressing the Fn (Function) button, or from the screens that are displayed by pressing the DRIVE or MENU button, etc.

When you start an operation, an operation guide that indicates a function of the multi-selector is displayed at the bottom of the screen.

- ◀▶: To the left/right for selection
- ⬆: Up/down for selection
- ⬆▶: Up/down/to the left/to the right for selection
- : Press the center button to execute the selection.

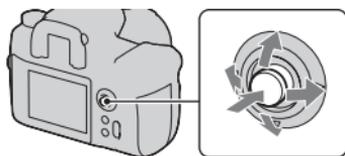

Move the multi-selector by following the instructions in the operation guide to select an item.

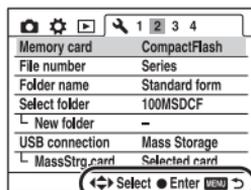

Operation guide

The operation guide list

The operation guide also indicates operations other than the multi-selector operation. The indications of icons are as follows.

Display	Indication
	MENU button
	Returns with MENU button
	button
	button
	Fn button

Display	Indication
	button
	Front or rear control dial
	Front control dial, rear control dial
	DISP button
	Returns with DISP button

Selecting the functions on the Quick Navi screen

Using the Quick Navi screen, you can change settings directly on the recording information display.

- 1 Press the Fn button so that the Quick Navi screen appears.**

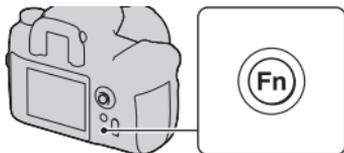

- 2 Following the operation guide, select the desired item with ▲/▼/◀/▶ on the multi-selector.**

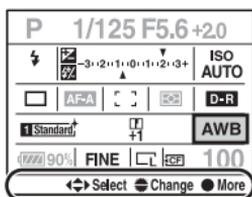

Operation guide

- 3 Set the item with the front or rear control dial.**

- For details on how to set up each item, see the corresponding page.
- Pressing the Fn button again turns off the Quick Navi screen.

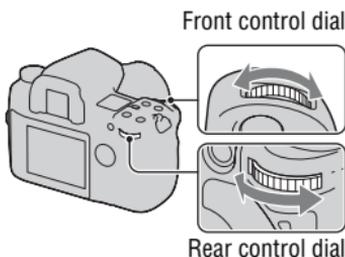

- Gray items on the Quick Navi screen are not available.
- When using Creative Style (page 78), some of the setup tasks can be accomplished only on the Exclusive disp screen.

To set up a function on the Exclusive disp screen

When the Quick Navi screen is displayed, pressing the center of the multi-selector turns on the Exclusive disp screen to set up the selected item. For details on how to set up each item, see the corresponding page.

AUTO Shooting with the automatic setting

The “AUTO” mode allows you to easily shoot any subject under any conditions.

1 Set the mode dial to **AUTO**.

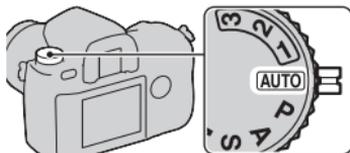

2 Hold the camera and look into the viewfinder.

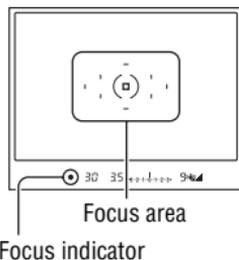

3 Press the shutter button halfway down to focus and press the shutter button fully down to shoot.

When the focus is confirmed, the focus indicator ● or (●) (Focus indicator) lights up (page 57).

Notes

- If you turn the camera off or change the exposure mode in the AUTO mode, the main shooting functions are reset to the default settings. The functions that are not reset are as follows:
 - Switch, dial, buttons:
The (⏏) switch, the diopter-adjustment dial, the items set with the DISP button, and the C button
 - Recording menu:
Image size, Aspect ratio, Quality, Exposure step, Memory
 - Custom menu/Playback menu/Setup menu:
All the items

- The actual setting may not correspond to the positions of the focus mode lever and metering mode lever on the camera. Refer to the information displayed on the LCD monitor when you take pictures.

Exposure mode

If you adjust the shutter speed or aperture, the effect on the picture is changed, even if it is the same subject. This camera has the following four modes.

The number positions (1/2/3) are used to recall the saved settings. See page 89.

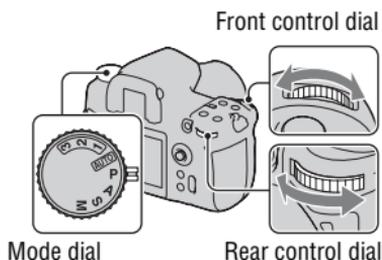

P: Program auto mode (below)

Allows you to shoot with the exposure adjusted automatically (both the shutter speed and the aperture value). The other settings can be adjusted, and your setting values can be saved.

A: Aperture priority mode (page 51)

Allows you to shoot after adjusting the aperture value manually. Shoots by controlling the blur of the background.

S: Shutter speed priority mode (page 52)

Allows you to shoot after adjusting the shutter speed manually. Shoots a moving subject with various expressions.

M: Manual exposure mode (page 53)

Allows you to shoot after adjusting the exposure manually (both the shutter speed and the aperture value).

P Shooting with Program auto

1 Set the mode dial to P.

2 Set the shooting functions to your desired settings.

The settings will be stored until you reset the settings.

Program Shift

You can temporarily change the shutter speed and aperture value combination with the correct exposure determined by the camera maintained.

1 Press the shutter button halfway down to adjust the focus.

The shutter speed and aperture value are indicated.

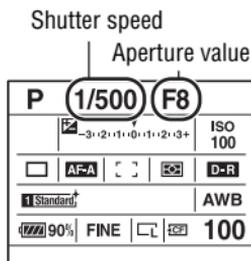

2 Rotate the front or rear control dial to select your desired combination while the focus is achieved.

Rotating the front control dial sets the exposure mode indicator to “P_S” (Shutter speed priority Program Shift) and rotating the rear control dial sets the exposure mode indicator to “P_A” (Aperture priority Program Shift).

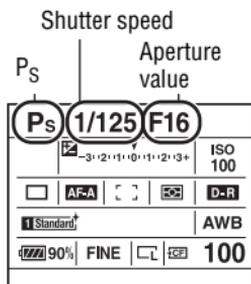

Notes

- If you turn the camera off and on or a certain period of time is passed, Program Shift “P_S” or “P_A” is canceled and returned to “P.”
- When Program Shift “P_S” is selected, the (Camera shake warning) indicator is not displayed.
- When a flash (sold separately) attached to the camera is turned on, Program Shift does not operate.

A Shooting with Aperture priority

If you set the aperture (a smaller F-number) wider, the in-focus range becomes narrower. Only the main subject is then in focus. When the aperture is smaller (a larger F-number), the in-focus range becomes wider. The whole image is sharpened. The shutter speed is automatically adjusted.

Wide aperture



Small aperture



1 Set the mode dial to A.

2 Select the aperture value (F-number) with the front or rear control dial.

- You can check the blurring of an image with the preview button (page 87).
- When the camera judges that the proper exposure is not obtained with the selected aperture value, the shutter speed flashes. In such cases, adjust the aperture again.
- The aperture value is adjusted in 1/3 EV increments. You can set this exposure step to 1/2 EV increments with [Exposure step] in the  Recording menu (page 108).

Aperture (F-number)

A		F5.6	
-3, -2, +1, +0, +1, +2, +3		ISO AUTO	
AF-A	AF-L	AF-ON	D-R
Standard		AWB	
90%		FINE	100

S Shooting with Shutter speed priority

If you shoot a moving subject at a higher shutter speed, it appears as if frozen on the image. At a lower shutter speed, the subject appears as if it flowing. Aperture value is automatically adjusted.

High shutter speed



Slow shutter speed



1 Set the mode dial to S.

2 Select the shutter speed with the front or rear control dial.

- The shutter speed is adjusted in 1/3 EV increments. You can set this exposure step to 1/2 EV increments with [Exposure step] in the Recording menu (page 108).

Shutter speed

S	1/500				
	-3+2+1+0+1+2+3+	ISO AUTO			
			D-R		
1 Standard		AWB			
	90%	FINE			100

Notes

- The (Camera shake warning) indicator is not indicated in shutter speed priority mode.
- When using the flash (sold separately), if you close the aperture (a larger F-number) by making the shutter speed slower, the light of the flash does not reach a distant subject.
- When the shutter speed is one second or slower, noise reduction (Long exp.NR) will be done after shooting. You cannot do any further shooting during the reduction.

M Shooting with Manual exposure

You can manually adjust the shutter speed and aperture values. This mode is useful when you maintain the setting of the shutter speed and the aperture value or when you use an exposure meter.

1 Set the mode dial to M.

2 Rotate the front control dial to adjust the shutter speed, and rotate the rear control dial to adjust the aperture.

- You can switch the functions of the front and rear control dial with [Ctrl dial setup] in the Custom menu (page 115).

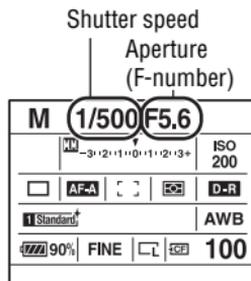

3 Shoot the image after the exposure is set.

- Check the exposure value on the EV scale.
Toward +: Images become brighter.
Toward -: Images become darker.
The ◀▶ arrow appears if the set exposure is beyond the range of the EV scale. The arrow starts flashing if the difference becomes greater. When the exposure is compensated, the standard value contains the compensated value.
 : Metered Manual

LCD monitor (Detailed display)



Standard value

Viewfinder

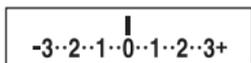

Standard value

Notes

- The (Camera shake warning) indicator is not indicated in manual exposure mode.
- When the mode dial is set to M, the ISO setting [AUTO] is set to [200]. In M mode, the ISO setting [AUTO] is not available. Set the ISO sensitivity as necessary.

Manual shift

You can change the shutter speed and aperture value combination without changing the exposure you set.

Rotate the front control dial while pressing the AEL button to select the shutter speed and aperture value combination.



AEL button

M Shooting with BULB

You can shoot trails of light, such as fireworks, with a long exposure.



1 Set the mode dial to M.

2 Rotate the front control dial to the left until [BULB] is indicated.

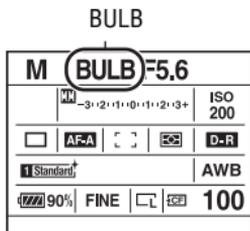

3 Rotate the rear control dial to adjust the aperture (F-number).

4 Press and hold the shutter button for the duration of the shooting.

As long as the shutter button is pressed, the shutter remains open.

- Using a Remote Commander (sold separately) reduces the camera shake and continues the exposure without pressing and holding the shutter button.

Notes

- When using a tripod, turn off the SteadyShot function.
- The longer the exposure time, the more outstanding the noise on the image.
- After shooting, noise reduction (Long exp.NR) will be done for the same amount of time that the shutter was open. You cannot do any further shooting during the reduction.

Selecting the focus method

Selecting the focus mode (Auto focus)

- 1 Set the focus mode lever to the desired position.**

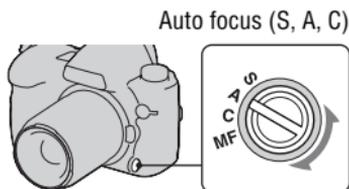

- 2 Press the shutter button halfway down to check the focus and shoot the image.**

- When the focus is confirmed, the focus indicator changes to ● or (●) (page 57).
- The area that the focus is confirmed in the AF area illuminated briefly in red.

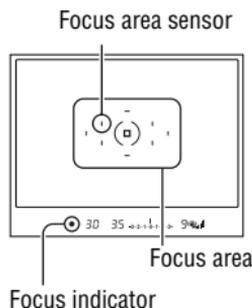

S (Single-shot AF) (AF-S)	The camera focuses on and the focus is locked when you press the shutter button halfway down. This is useful when shooting a motionless subject.
A (Automatic AF) (AF-A)	The AF mode is switched between Single-shot AF and Continuous AF according to the movement of the subject. When you press and hold the shutter button halfway down, if the subject is motionless, the focus is locked and if the subject is in motion, the camera continues to focus. In continuous shooting, the second and later shots are automatically set to Continuous AF.
C (Continuous AF) (AF-C)	The camera continues to focus while the shutter button is pressed and held halfway down. This is useful when the subject is in motion. <ul style="list-style-type: none">• If the AF area is set to [] (Wide), the AF area switches to match the position of the subject.• The audio signals will not sound when the subject is in focus.

- You can set the function of the “A” position of the focus mode lever to DMF (Direct Manual Focus) with [AF-A setup] in the  Recording menu (page 61).

Focus indicator

Focus indicator	Status
 lit	Focus locked. Ready to shoot.
 lit	Focus is confirmed. Focal point moves following a moving subject. Ready to shoot.
 lit	Still focusing. You cannot release the shutter.
 flashing	Cannot focus. The shutter is locked.

Subjects that may require special focusing:

Using the auto focus, it is hard to focus on the following subjects. In such cases, use the focus lock shooting feature (page 59) or manual focus (page 60).

- A subject that is low in contrast, such as blue sky or a white wall.
- Two subjects at different distances overlapping in the AF area.
- A subject that is composed of repeating patterns, such as the facade of a building.
- A subject that is very bright or glittering, such as the sun, the body of an automobile, or the surface of water.

To measure the exact distance to the subject

The  mark on the camera shows the location of the image sensor. When you measure the exact distance between the camera and the subject, refer to the position of the horizontal line.

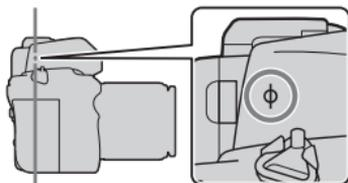

Selecting the focus area

Select the desired AF area to suit the shooting conditions or your preference. The area used for focusing is illuminated briefly.

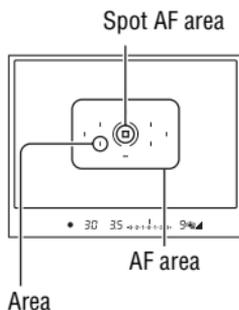

1 Press the Fn button to display the Quick Navi screen (page 46).

2 Select the AF area item with ▲/▼/◀/▶ on the multi-selector.

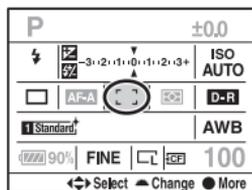

3 Select the desired mode with front or rear control dial.

[] (Wide)	The camera determines which of the nine AF areas is used in focusing within the AF area. The camera focuses on a subject using 10 supplementary ranging points, in addition to the normal nine ranging points, to focus with a high degree of accuracy. If you press and hold the center of the multi-selector, [AF area] is temporarily set to [Spot] and you can adjust the focus using the spot AF area.	
[Spot] (Spot)	The camera uses the spot AF area exclusively.	



(Local)

Choose the area for which you want to activate the focus from among nine areas with the multi-selector during the shooting. To select the spot AF area, press the center of the multi-selector.

Notes

- The supplementary ranging points are activated only when [] (Wide) is selected. They are not displayed in the viewfinder.
- The AF area may not be illuminated during continuous shooting or when the shutter button is pressed all the way down without pause.

Shooting with focus-lock

If the subject is off-center and outside the AF area, lock the focus by following the steps below.

- 1 Place the subject within the AF area and press the shutter button halfway down.**



- 2 Keep the shutter button halfway down, and re-compose the shot.**



- 3 Press the shutter button fully down to take the picture.**

- Pressing the center of the multi-selector also locks the focus on the spot AF area (page 58).
- You can also use the AF/MF button to lock the focus with [AF/MF button] in the ⚙ Custom menu (page 113).

AF illuminator

Press the shutter button halfway down, a red illuminator is automatically emitted until the focus is locked, according to the situation.

When you shoot a subject under dark conditions, or when you shoot a low contrast subject, the AF illuminator allows the camera to focus more easily on the subject.

AF illuminator



- The AF illuminator does not operate when the focus mode is set to Continuous AF or the subject is moving in Automatic AF.
- The AF illuminator does not operate when the center area is not selected with [AF area] set to  (Local).
- The AF illuminator may not operate with focal lengths of 300 mm or longer.
- When a flash (sold separately) is attached, the AF illuminator of the flash is used.
- You can deactivate the AF illuminator with [AF illuminator] in the  Recording menu (page 109).

Shooting with Manual focus

You can set the distance of a subject.

1 Set the focus mode lever to MF.

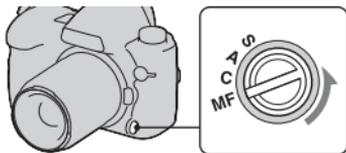

2 Rotate the focusing ring of the lens to achieve a sharp focus.



Notes

- In the case of a subject that can be focused in auto focus mode, the ● indicator lights up in the viewfinder when the focus is confirmed. When the Wide AF area is selected, the center area is used, and when the Local AF area is selected, the area that is selected with the multi-selector is used.
- The camera resets the focal length to ∞ (infinity) when you turn the camera on.
- When using a tele converter, etc., rotation of the focusing ring may not be smooth.
- When you turn the camera off and then on again with the mode dial set to “AUTO,” or change the exposure mode to AUTO from another mode, AF (Auto focus) is automatically selected, regardless of the position of the focus mode lever (page 47).

Shooting with Direct manual focus

You can make fine adjustments after adjusting the focus in auto focus (Direct manual focus). You can assign this function to the “A” position of the focus mode lever.

You can quickly focus on a subject rather than using the manual focus from the beginning. This is convenient in cases such as macro shooting.

1 Press the MENU button, and select [AF-A setup] → [DMF] in the  Recording menu 3 with the ▲/▼/◀/▶ on the multi-selector.

2 Set the focus mode lever to “A.”

3 Press the shutter button halfway down to lock the focus.

4 Turn the focusing ring to fine-tune the focus while pressing the shutter button halfway down.

Switching the AF/MF easily

You can switch between auto focus and manual focus without relaxing your position (AF/MF control).

Press the AF/MF button.

In auto focus mode: The focus mode is switched temporarily to the manual focus. Press and hold the AF/MF button and adjust the focus by rotating the focusing ring.

In manual focus mode: The focus mode is switched temporarily to the auto focus and the focus is locked.

- You can maintain the selected mode without pressing and holding the AF/MF button with [AF/MF control] in the ⚙ Custom menu (page 113).

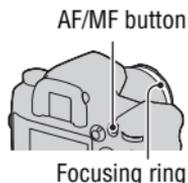

Using a flash (sold separately)

In a dark location, using the flash allows you to shoot the subject brightly, and it also helps to prevent camera shake. When shooting into the sun, you can use the flash to shoot a bright image of the backlit subject.

For details on how to use the flash, refer to the operating instructions supplied with the flash.

1 Remove the accessory shoe cap and attach the flash (sold separately).

- Firmly push the flash into the accessory shoe in the direction of the arrow until it stops.



2 Turn the flash on and after the flash charging is completed, shoot the subject.

- ⚡ Flashing: The flash is being charged.
- ⚡ Lit: The flash has been charged.
- When you press the shutter button halfway down under dark lighting in auto focus mode, the AF illuminator of the flash may be emitted.

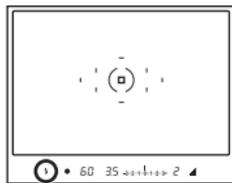

⚡ (Flash charging) indicator

Note

- The lens may block the light of the flash and a shadow may appear on the bottom of the image. Remove the lens hood.

Selecting the flash mode

1 Press the Fn button to display the Quick Navi screen (page 46).

- When the enlarged display screen is used, set up from the menu (page 102).

2 Select the flash item with ▲/▼/◀/▶ on the multi-selector.

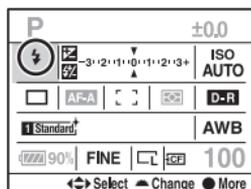

3 Select the desired mode with the front or rear control dial.

 (Autoflash)	Fires if it is dark or against light. This is selectable only when the AUTO mode is selected.
 (Fill-flash)	Fires every time the shutter is released.
 (Rear sync.)	Fires right before the exposure is completed. You can capture a flowing light or the trail of a moving subject in a more realistic way when shooting a moving subject using a slower shutter speed with the flash.
 (Wireless)	Rather than attaching a flash on the camera, you can create more contrast, resulting in a more three-dimensional picture. Two or more wireless flashes* are required, including an HVL-F58AM. *HVL-F58AM, HVL-F56AM, HVL-F42AM, HVL-F36AM

To perform wireless flash shooting

- ① Set the flash mode of the camera to  (Wireless).
- ② Set the HVL-F58AM as the wireless controller and attach it to the camera.
- ③ Place the other flash apart from the camera.
- ④ If you perform a test fire of the flash, press the AEL button.
It is recommended that you set [AEL button] to [AEL hold] or [AEL hold] in the  Custom menu.
If you select [AEL toggle] or [AEL toggle], every test fire will cause the slow sync recording mode to switch on and off.

⑤ Shoot the image.

The flash of the HVL-F58AM and another flash are fired.

Notes

- Change the channel of the external flash when another photographer is using a wireless flash nearby and his/her flash light triggers firing of your flash. To change the channel of the external flash, refer to the operating instructions supplied with it.
- For details on the wireless flash, refer to the operating instructions supplied with the flash.

Shooting with Slow Sync

If you use the slow sync shooting feature with a slower shutter speed, you can capture a clear image of both the subject and the background. This is convenient when you shoot a portrait at night with a dark background.

Shoot with the SLOW SYNC button pressed.

* in the viewfinder and on the LCD monitor lights up to indicate the exposure is locked.

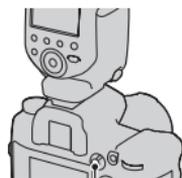

SLOW SYNC button

Note

- In shutter speed priority mode or manual exposure mode, slow sync shooting is not available using the SLOW SYNC button.

Shooting with High Speed Sync (HSS)

Since the flash sync speed restriction is removed when you use one of the HVL-F58AM, HVL-F56AM, HVL-F42AM or HVL-F36AM models, the flash allows you to take pictures using the flash with the entire shutter speed range of the camera. It also enables you to take pictures with the flash in bright conditions with the aperture open. In high speed sync mode, “H” or “HSS” appears in the viewfinder and on the LCD monitor.

Notes

- High speed sync mode is not available when the two-second self-timer or mirror lockup shooting is selected, or the flash mode is set to  (Rear sync.).

- For details on High Speed Sync, refer to the operating instructions supplied with the flash.

Using a flash equipped with a flash sync terminal cord

Open the cover of the ⚡ (flash sync) terminal and plug the cord in.

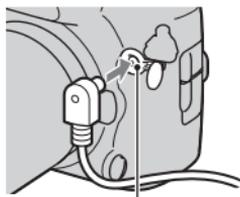

⚡ (flash sync) terminal

- You can use a flash equipped with a flash sync terminal of the opposite polarity.

Notes

- Select the manual exposure mode and set the shutter speed to 1/200 second with the SteadyShot on or 1/250 second with the SteadyShot off. If the shutter speed recommended on the flash is slower than that, use the recommended speed or an even slower speed.
- Use a flash with a flash sync voltage of 400 V or less.
- Before you connect the flash sync cord to the ⚡ (flash sync) terminal, turn off the power of the connected flash. If the power is on, it may flash when you connect the cord.
- The flash will always be full emission. Flash compensation (page 71) cannot be used.
- Using auto white balance is not recommended. Use custom white balance to gain more precise white balance.
- The flash indicator is not displayed when the ⚡ (flash sync) terminal is plugged in.

Adjusting the brightness of the image (Metering, Exposure, Flash compensation)

Selecting the Metering mode

You can select the method for measuring the brightness of a subject.

Select the desired mode with the metering mode lever.

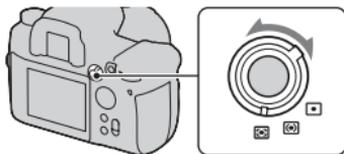

<input checked="" type="checkbox"/> (Multi segment)	This divides the whole screen into 40 segments to measure light (40-segment honeycomb pattern metering). This metering method enables the camera to measure light in a way most similar to that of the human eye, which is ideal for general shooting, including shooting into direct sunlight.
<input checked="" type="checkbox"/> (Center weighted)	While emphasizing the central area of the screen, this mode measures the average brightness of the entire screen.
<input type="checkbox"/> (Spot)	This mode measures light only in the spot metering circle in the center of the frame. This is suitable for shooting a subject with strong contrast or measuring the light of a specific area of the screen.

Multi segment metering

The screen of this camera is equipped with 39 honeycomb shaped metering elements and one metering element that covers the surrounding area. These elements work in sync with auto focus, allowing the camera to accurately measure the position and brightness of the subject in order to determine the exposure.

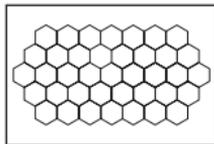

- In multi segment metering, if the focus is locked, the exposure (the shutter speed and the aperture) is locked simultaneously (only when Single-shot AF or Automatic AF).

Compensating the exposure

Except for exposure mode M, the exposure is automatically acquired (Automatic exposure).

Based on the exposure acquired by the automatic exposure, you can perform exposure compensation, depending on your preference. You can make the entire image brighter by shifting it to the + side. The entire image becomes darker when you shift it to the - side.

Adjust in the -
direction



Base exposure



Adjust in the +
direction



1 Press the  button to display the exposure compensation screen.

 button



2 Adjust the exposure with ◀/▶ on the multi-selector.

- You can use the front or rear control dial instead.

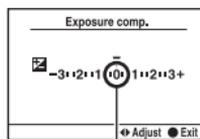

Standard exposure

- The exposure is compensated by 1/3 of a step between ± 3.0 EV. You can set this exposure step to 1/2 EV increments with [Exposure step] in the Recording menu (page 108).

To compensate the exposure only on the ambient light*

In the default setting, the exposure compensation is performed with the amount of flash light also changed when the flash is fired. You can limit the effect of exposure compensation to the background that is illuminated only by ambient light (light other than the flash) (page 118).

* Ambient light: Any light other than the flash light that shines on the scene for an extended period of time, such as natural light, a light bulb, or a fluorescent light.

Shooting with fixed brightness (AE Lock)

You can fix the exposure before deciding on the composition when taking a picture. This is effective when the metering object and focusing object are different, or when you want to shoot continuously while keeping the same exposure value.

1 Target the subject for which you want to meter the exposure.

- Adjust the focus (you do not need to lock the focus.)

2 Press the AEL button to lock the exposure.

* (AE lock mark) appears in the viewfinder and on the LCD monitor.



AEL button

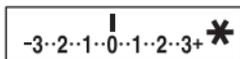

3 While pressing the AEL button, recompose the image, if necessary, and shoot the image.

- If you continue to shoot with the same exposure value, press and hold the AEL button after the shooting. The setting is canceled when the button is released.
- You can change the function and operation of the AEL button with [AEL button] in the ⚙ Custom menu (page 115).

To check the exposure of the image

Hold down the AEL button and place the spot metering circle on the spot where the lighting is contrasted from the subject.

The metering indicator displays the degree of exposure difference, zero being the locked exposure.

Shifting to the + side makes the image brighter, and shifting to the – side makes the image darker.

When the image is too bright or too dark to get the proper exposure, ◀ or ▶ appears or flashes at the end of the indicator.

Spot metering circle

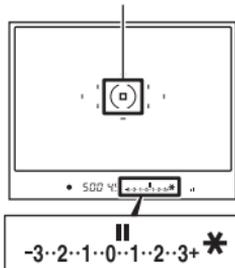

Adjusting the amount of flash light (Flash compensation)

When shooting with the flash, you can adjust the amount of flash light alone, without changing the exposure compensation. You can only change the exposure of a main subject which is within the flash range.

Adjusting it toward + makes the flash level higher and adjusting it toward - makes the flash level lower.

1 Press the Fn button to display the Quick Navi screen (page 46).

2 Select the flash compensation item with ▲/▼/◀/▶ on the multi-selector.

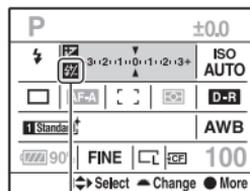

Flash compensation

3 Select the desired compensation value with the front or rear control dial.

Notes

- If you have adjusted the flash level,  appears in the viewfinder when the flash is attached on. When you adjust it, be careful not to forget to reset the value.
- The positive effect may not be visible due to the limited amount of flash light, if the subject is at or around the maximum range for the flash. If the subject is very close, the negative effect may not be visible.

Exposure compensation and flash compensation

Exposure compensation changes the shutter speed, aperture, and ISO sensitivity (when [AUTO] is selected) to perform the compensation. If the flash is used, the amount of flash light is also changed.

However, flash compensation only changes the amount of flash light.

Setting ISO

Sensitivity to light is expressed by the ISO number (recommended exposure index). The larger the number, the higher the sensitivity.

1 Press the ISO button to display the ISO screen.



2 Select the desired value with ▲/▼ on the multi-selector.

- You can use the front or rear control dial instead. The number is incremented by 1 step using the front control dial and it is incremented by 1/3 step using the rear control dial.

Notes

- The available luminosity limits for an image (dynamic range) are a little narrower in the range less than ISO 200. When ISO 3200 or higher is selected, the range is treated as an expanded range and the noise is more noticeable. Adjust the ISO number after you check the amount of noise on the image.
- The [AUTO] setting is not provided in exposure mode M. If you change the exposure mode to M with the [AUTO] setting, it is switched to [200]. Set the ISO according to your shooting conditions.
- You can adjust the range of [AUTO] with [ISO Auto Range] in the  Recording menu (page 108).

Adjusting the color tones (White balance)

White balance is a feature that adjusts the color tone to approximate what you see. When [AWB] (Auto WB) is selected, the white balance is automatically adjusted. However, you can use this feature when the color tone of the image did not come out as you expected, or when you want to change the color tone on purpose for photographic expression.

WB button



The color tone of the subject changes depending on the characteristics of the light source. The table below shows how the color tone changes based on various light sources, compared with a subject that appears white under the sunlight.

Weather/lighting	Daylight	Cloudy	Fluorescent	Incandescent
Characteristics of light	White	Bluish	Green-tinged	Reddish

Note

- If the only light source available is a mercury lamp or a sodium lamp, the camera will not be able to acquire the accurate white balance because of the characteristics of the light source. Use the flash in such cases.

Auto/Preset white balance

- 1 Press the WB button to display the White balance mode screen.**
- 2 Select the desired mode with ▲/▼ on the multi-selector.**

- You can use the front control dial instead.

3 Select a preset white balance, then finely adjust the color tone with ◀/▶ on the multi-selector, if necessary.

Adjusting it toward + turns the image reddish and adjusting it toward – turns the image bluish. (The increment is equivalent to about 10 Mired*.)

- You can use the rear control dial instead.

* Mired: a unit to indicate the color conversion quality in color temperature filters.

AWB (Auto WB)	Approx. 3000 to 7500K	The camera automatically detects a light source and adjusts the color tones.
 (Daylight)	Approx. 5300K	If you select an option to suit a specific light source, the color tones are adjusted for the light source (preset white balance).
 (Shade)	Approx. 7500K	
 (Cloudy)	Approx. 6100K	
 (Tungsten)	Approx. 2800K	
 (Fluorescent)	– *	
 (Flash)	Approx. 6500K	

* Since the color of fluorescent light cannot be expressed by the color temperature, the color temperature is omitted.

On fluorescent light

When  (Fluorescent) is selected, adjusting the value with ◀/▶ on the multi-selector selects the types of fluorescent light; it does not perform a fine adjustment.

- In a scene where the ambient light consists of multiple types of light source, if you cannot properly adjust the white balance using [AWB] (Auto WB) or the preset white balance options, use the custom white balance (page 75).

Setting the color temperature and a filter effect

1 Press the WB button to display the White balance mode screen.

2 Select [5500K] (ColorTemperature) or [0] (Color filter) with ▲/▼ on the multi-selector.

- To set the color temperature, select the value with ◀/▶.
- To set the color filter, select the compensation direction with ◀/▶.

5500K * ¹ (ColorTemperature)	Sets the white balance by the color temperature. The higher the number, the more reddish the image and the lower the number, the more bluish the image. The color temperature can be selected between 2500K and 9900K.
0 * ² (Color filter)	Achieves the effect of CC (Color Compensation) filters for photography. Based on using the set color temperature as the standard, the color can be compensated to G (Green) or M (Magenta). The color filter value can be selected between G9 and M9. The increment is approximately equivalent to CC filter number 5.

*1 The value is the color temperature value currently selected.

*2 The value is the color filter value currently selected.

Note

- Since most of the color meters are designed for film cameras, using the measurements obtained from them may not give correct results under fluorescent/sodium lamp/mercury lamps. We recommend that you perform the compensation according to a test shooting or use the custom white balance.

Custom white balance

In a scene where the ambient light consists of multiple types of light source, use of custom white balance is recommended in order to accurately reproduce the whiteness. You can register three settings.

1 Press the WB button to display the White balance mode screen.

2 Select [1]* (Custom white balance) with ◀/▶ on the multi-selector, then press the center of the multi-selector.

* Any number between 1 and 3 is indicated.

3 Select [ SET] with ◀/▶ on the multi-selector, then press the center of the multi-selector.

4 Hold the camera so that the white area fully covers the spot-metering circle and press the shutter button down.

The shutter clicks and the calibrated values (ColorTemperature and Color filter) are displayed.

5 Select a memory number with ◀/▶, press the center of the multi-selector.

The monitor returns to the recording information display with the memorized custom white balance setting retained.

- The custom white balance setting is registered in this operation is effective until a new setting is registered.
-

Note

- The message “Custom WB error” indicates that the value is beyond the expected range. (When the flash is used on a subject in close proximity or a subject with a bright color is in the frame.) If you register this value, the  indicator turns yellow on the recording information display on the LCD monitor. You can shoot at this point, but it is recommended that you set the white balance again to get a more correct white balance value.

To call the custom white balance setting

In step 3, select the desired number.

Note

- If the flash is used when the shutter button is pressed, a custom white balance is registered with the flash light taken into account. Take pictures with the flash in later shootings.

Image processing

Using the D-Range Optimizer

The camera analyzes the subject almost instantly and automatically compensates to improve the image quality with the optimal brightness and gradation. You can shoot images with the natural color that you intend to reproduce.

1 Press the Fn button to display the Quick Navi screen (page 46).

2 Select the D-Range Optimizer item with ▲/▼/◀/▶ on the multi-selector.

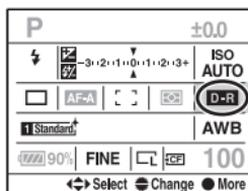

3 Select the desired mode with the front control dial.

- To adjust **D-RO** (Advanced: Level), use the rear control dial.

D-ROFF (Off)	No compensation.
D-RO (Standard)	When there is a high contrast of light and shadow between the subject and the background, which is common when shooting into the sun, the camera attenuates the contrast across the entire image to produce an image with proper brightness and contrast.
D-ROA (Advanced Auto)	By dividing the image into small areas, the camera analyzes the contrast of light and shadow between the subject and the background, producing the image with the optimal brightness and gradation.
D-ROL (Advanced: Level)	The level is selected between Lv 1 (weak) and Lv 5 (strong).

Notes

- Since the speed of continuous shooting may be slower in **D-ROA** (Advanced Auto), we recommend that you select **D-RO** (Standard) in situations, including shooting sports images you need high speed continuous shooting.

- For enlarged RAW images, the effects of the D-Range optimizer other than **D-R** (Standard) cannot be checked on the camera.
- When shooting with the D-Range optimizer, the image may be noisy. Especially when you enhance the effect with **D-R** (Advanced: Level), select the level by checking the recorded image.

Using the Creative Style

This Creative Style is pre-programmed with image styles optimal for various scenes and purposes. You can take a picture with an appropriate level of color reproduction and tone. Besides, using these image styles as a base, you can produce an image to meet your needs.

1 Press the Fn button to display the Quick Navi screen (page 46).

2 Select a Creative Style item with ▲/▼/◀/▶ the multi-selector, then press the center of the multi-selector.

- If you are only selecting a style box, you can perform the operation on the Quick Navi screen.

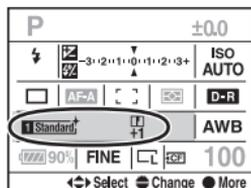

3 Select the desired image style with ▲/▼ on the multi-selector.

In the default setting, you can select from Standard, Vivid, Neutral, Portrait, Landscape, or B/W.

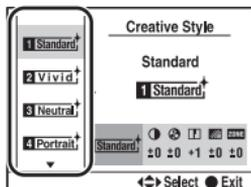

4 Move the cursor to the right with ▶ on the multi-selector, and set up parameters with ▲/▼ on the multi-selector.

For available image styles and parameters, see below.

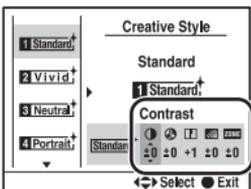

To use image styles other than the default ones

- ① Select the style box for which you want to change the setting.
- ② Move the cursor to the right with ► on the multi-selector, and select the desired image style with ▲/▼ on the multi-selector.

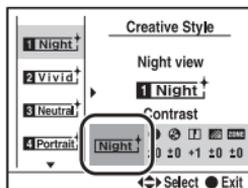

Image styles

Standard † (Standard)	For capturing various scenes with rich gradation and beautiful colors.
Vivid † (Vivid)	The saturation and contrast are heightened for capturing striking images of colorful scenes and subjects such as flowers, spring greenery, blue sky, or ocean views.
Neutral † (Neutral)	The saturation and sharpness are lowered for capturing images in a quiet tone. This is also suitable for capturing image material to be modified with a computer.
Clear † (Clear)	For capturing images in a clear tone with limpid colors in the highlighted area, suitable for capturing radiant light.
Deep † (Deep)	For capturing images with deep and dense color expressions, suited to capturing the solid presence of the subject.
Light † (Light)	For capturing images with bright and uncomplicated color expressions, suited to capturing refreshingly light ambience.
Portrait † (Portrait)	For capturing the skin color in a soft tone, ideally suited to capturing portraits.
Landscape † (Landscape)	The saturation, contrast, and sharpness are heightened for capturing vivid and crisp scenery. Distant landscapes also stand out more.
Sunset † (Sunset)	For capturing the beautiful red of the setting sun.
Night † (Night view)	The contrast is attenuated for capturing a nightscape that is more faithful to the real view.
Autumn leaves † (Autumn leaves)	For capturing autumn scenes, vividly highlighting the red and yellow of coloring leaves.
B/W † (B/W)	For capturing images in black and white monotone.
Sepia † (Sepia)	For capturing images in sepia monotone.

Parameters

 (Contrast)	The higher the value selected, the more the difference of light and shadow is accentuated, thus making an impact on an image.
 (Saturation)	The higher the value selected, the vividder the color. When a lower value selected, the color of the image is restrained and quiet.
 (Sharpness)	Adjusts the sharpness. The higher the value selected, the more the highlighting of the contours is accentuated, and the lower the value selected, the more the highlighting of the contours is softened.
 (Brightness)	Adjusts the brightness of an entire image.
 (Zone)	Preventing an image from becoming overexposed or underexposed, a rich tone is reproduced. When a higher value is selected, it prevents an image from becoming overexposed when shooting a bright area subject; and when a lower value is selected, it prevents an image from becoming underexposed when shooting a dark area subject.

Notes

- When  (B/W) or  (Sepia) is selected, you cannot adjust the saturation.
- If you adjust  (Zone), you cannot adjust  (Contrast).

Selecting the drive mode

This camera has nine drive modes, such as single-shot advanced, continuous advanced. Use them for your purpose.

- 1 Press the **DRIVE** button to display the setup screen.

DRIVE button



- 2 Select the desired mode with **▲/▼** on the multi-selector, then select the desired setting with **◀/▶** on the multi-selector.

	Single-shot adv. (page 81)
	Continuous adv. (page 82)
	Self-timer (page 83)
BRK C	Bracket: Cont. (page 83)
BRK S	Bracket: Single (page 83)
BRK WB	WB bracket (page 85)
BRK D-R+	DRO adv. bracket (page 85)
	Mirror lockup (page 85)
	Remote Commander (page 86)

- You can substitute the Fn button for the DRIVE button to set up on the Quick Navi screen (page 46).

Shooting single shot

This mode is for normal shooting.

This is also used for canceling other drive modes.

Shooting continuously

The camera records the images continuously at a maximum of 3 images per second*.

* Our measurement conditions: [Image size] is set to [L:24M], [Quality] is set to [Fine], the focus mode is set to Single-shot AF or manual focus, and the shutter speed is 1/250 second or faster.

However, the speed of continuous shooting is slower when shooting under dark conditions, the D-Range Optimizer is set to  (Advanced Auto) or  (Advanced: Level), or [High ISO NR] is set to [High].

The maximum number of continuous shots (Media used for the measurement: Sony CompactFlash Card NCFD2G (300× 4GB))

The number of continuous shooting images obtainable has an upper limit.

RAW	16 images
cRAW	18 images
RAW & JPEG	12 images
cRAW & JPEG	12 images
Extra fine	34 images
Fine/Standard	384 images/593 images

The number of images that can be shot continuously is indicated in the viewfinder. When the available number of continuous shots is more than nine images, “9” is indicated in the viewfinder.

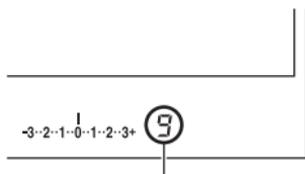

The number of images that can be shot continuously

Note

- When the capacity of the memory card is insufficient, the camera may not continuously shoot all the images indicated in the viewfinder.

Using the self-timer

☺ 10	After you press the shutter button, the shutter will be released about ten seconds. When the self-timer is activated, audio signals and the self-timer lamp indicate the condition. The self-timer lamp flashes quickly and the audio signal sounds quickly right before the shooting.
☺ 2	After you press the shutter button, the shutter will be released about two seconds. This is convenient to reduce the camera shake because the mirror moves upward before shooting.

To cancel the 10-second self-timer

Press the DRIVE button.

Notes

- When you press the shutter button without looking into the viewfinder, close the eyepiece shutter with the eyepiece shutter lever.
- When the 2-second self-timer is selected, the following shooting features cannot be used: high speed sync shooting, WL high speed sync, and mirror lockup shooting.

Shooting with Exposure bracket

Bracket shooting allows you to shoot several images, each with different degrees of exposure. This camera is equipped with an auto bracket function. Specify the value of deviation (steps) from the base exposure, and the camera shoots while automatically shifting the exposure. You can choose an image that has the brightness you like after shooting is finished. The base exposure is set at the first shot in the bracket.

Base exposure



- direction



+ direction



BRK C * (Bracket: Cont.)	Shoots three or five images with the exposure shifted by a selected step. Press and hold the shutter button until the recording stops.
BRK S * (Bracket: Single)	Shoots three or five images with the exposure shifted by a selected step. Press the shutter button shot by shot.

* $_ _$ EV beneath **BRK C** / **BRK S** is the step currently selected and $_$ to the right of EV is the number currently selected.

- In the default setting, the camera shoots in the order $0 \rightarrow - \rightarrow +$. You can change this order to $- \rightarrow 0 \rightarrow +$, with [Bracket order] in the  Custom menu (page 118).

Notes

- When the mode dial is set to M, the exposure is shifted by adjusting the shutter speed. If you shift the exposure by adjusting the aperture value, press and hold the AEL button and shoot the image.
- When you adjust the exposure, the exposure is shifted based on the compensated value with bracket shooting.
- When the flash is not used, ambient bracket shooting is performed and the shutter speed and aperture are changed to accommodate bracket shooting. When the flash is used, flash bracket shooting is performed and the flash light is changed.
- In flash bracket shooting, single shot is automatically selected regardless of the single/continuous setting. Press the shutter button shot by shot.

The example of the EV scale in bracket shooting

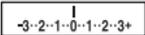
	Ambient bracket 0.3 steps, three shots Exposure compensation 0	Flash bracket 0.7 steps, three shots Flash compensation -1.0
LCD monitor	 Shown in the top row.	 Shown in the bottom row.
Viewfinder	 Shown in the top row.	 Shown in the bottom row.

- In ambient bracket shooting, the EV scale appears in the viewfinder, too, but it does not appear in flash bracket shooting.
- When the bracket shooting starts, the indexes that indicate already recorded images start to disappear one by one.

- When Single bracket is selected, if the shutter button is pressed halfway down and released, “br 1” appears for the ambient light bracket and “Fbr 1” appears for the flash bracket in the viewfinder. When bracket shooting starts, it indicates what number the next frame is, for instance, “br 2,” “br 3.”

Shooting with the white balance bracket

Based on the selected white balance value three images are taken per one shooting with the color temperature shifted.

BRK WB * (WB bracket)	When Lo is selected, it is shifted by 10 mired, and when Hi is selected, it is shifted by 20 mired.
------------------------------	---

* The value beneath **BRK WB** is the value currently selected.

Shooting with the DRO advanced bracket

DRO advanced bracket shooting takes three pictures per one shooting while separately changing the optimizing level of the gradation in each image area.

(DRO: D-Range Optimizer)

BRK D-R+ * (DRO adv. bracket)	When Lo is selected, it is shifted slightly, and when Hi is selected, it is shifted widely.
--------------------------------------	---

* The value beneath **BRK D-R+** is the value currently selected.

Notes

- When DRO advanced bracket shooting is selected, the D-Range Optimizer setting (page 77) is temporarily deactivated.
- You cannot verify the effects of D-Range Optimizer other than those of **D-R** (Standard) if you play back and enlarge an image recorded in RAW format.

Shooting with the mirror lockup function

Moving the mirror upward before shooting prevents camera shake when the shutter is released. This feature is convenient when you perform macro shooting or shoot with a telephoto lens, because even slight camera shake affects the image.

1 Press the shutter button.

The focus and exposure are locked and the mirror moves upward.

2 Press the shutter button again to shoot.

- If you use the Remote Commander (sold separately), you can reduce the camera shake furthermore.

Notes

- The mirror automatically moves downward after 30 seconds from the time the mirror is moved upward. Press the shutter button again.
- High speed sync shooting and WL high speed sync shooting cannot be used during mirror lockup shooting.
- In mirror lockup shooting, do not touch the shutter or strongly blow on the shutter using a blower. These may cause damage to the camera.
- When you press the shutter button without looking into the viewfinder, close the eyepiece shutter with the eyepiece shutter lever.

Shooting with the Wireless Remote Commander

You can shoot using the SHUTTER and 2SEC (the shutter is released after 2 seconds) buttons on the RMT-DSLR1 Wireless Remote Commander (sold separately). Also, refer to the operating instructions supplied with the Wireless Remote Commander.

Focus on the subject, point the transmitter of the Remote Commander to the remote sensor, and shoot the image.

- In BULB shooting, the camera starts exposure when you press the SHUTTER or 2 SEC button, and when you press the SHUTTER or 2 SEC button again, the camera stops exposure.

Notes

- When you press the shutter button without looking into the viewfinder, close the eyepiece shutter with the eyepiece shutter lever.
- To lock the focus, press the shutter button on the camera halfway down and release the button, then shoot with the Remote Commander. After shooting, the focus remains locked. Any operation on the camera will release the focus lock.

Using the preview function

You can check the approximate sharpness of the subject in the viewfinder before the actual shooting (Optical preview).

Then, you can check the condition of the image on the LCD monitor on the rear of the camera beforehand, and on the same screen, you can check and adjust the effect of the exposure, white balance, D-Range Optimizer, and so on (Intelligent preview).

1 Focus on the subject and press the preview button.

While the button is held down, the aperture is narrowed to match the aperture value displayed in the viewfinder (Optical preview).

- You can adjust the aperture during the preview.

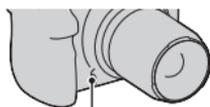

Preview button

2 Release the preview button.

The image is displayed on the LCD monitor (Intelligent preview).

- Maintain the camera position until the image is displayed on the LCD monitor after releasing the button.

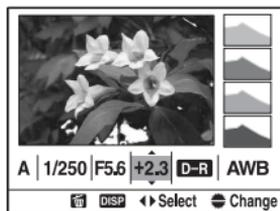

3 Select an item with ◀/▶ on the multi-selector, then adjust the value with the front or rear control dial.

The adjusted value is maintained except for some functions.

- Pressing the DISP button compares the modified image to the original image. Pressing it again returns to the modified image.
- Pressing the  button returns the values to the original values.

4 Press the shutter button halfway down, and clear the Intelligent preview screen to shoot.

When you want to activate only the Optical preview function

Set [Preview Function] to [Optical Preview] in the ⚙ Custom menu (page 114).

Notes

- The image in the viewfinder will be darker during the Optical preview.
- The auto focus does not function during an Optical preview. Focus on the subject beforehand.
- The Intelligent preview feature cannot be used during BULB shooting.
- The Intelligent preview feature cannot be used when the buffer memory of the camera is full.

Registering your own settings

You can register three combinations of frequently used modes and settings in the memory. You can recall the registered settings with the mode dial.

1 Put the camera on the setting you want to register.

2 Press the MENU button, and select [Memory] in the  Recording menu 4 with  on the multi-selector.

3 Select the number you want to register with  on the multi-selector, then press the center of the multi-selector.

- You can rewrite the settings as many times as you like.

Items that can be registered

Exposure mode, drive mode, ISO, white balance, exposure compensation, metering mode, focus mode, the position of the local AF area, and all of the  Recording menu items (pages 104 to 112)

To recall the saved settings

Set the mode dial to the desired number position.

You can change the settings by following the steps above after you have recalled a saved setting.

Notes

- You cannot register the Program Shift and Manual Shift settings.
- The actual setting will not correspond to the positions of the dials and levers on the camera. Refer to the information displayed on the LCD monitor when you take pictures.

Playing back images

The last recorded image is displayed on the LCD monitor.

1 Press the  button.

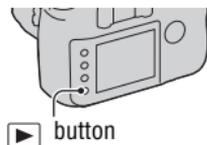

2 Select an image with   on the multi-selector.

To return to the shooting mode

Press the  button again.

To switch the recording data display

Press the DISP button.

Each time you press the DISP button, the screen changes as follows.

Displays previous or next images, up to five images.

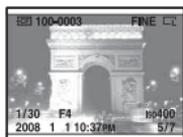

With recording data



With recording data



Without recording data

Displaying the histogram

A histogram is the luminance distribution that shows how many pixels of a particular brightness exist in the picture.

Press the button.

The histogram and recording data of the displayed image are displayed.



 button

To return to the normal playback screen

Press the  button again.

How to check the histogram

When the image has a bright or dark area portion, that portion is flashed on the histogram display (Luminance limit warning).

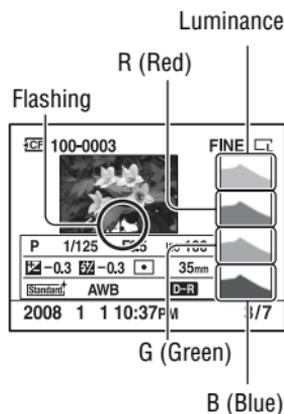

The exposure compensation will change the histogram accordingly. The right illustration is an example.

Shooting with the exposure compensation on the positive side brightens the whole picture, making the entire histogram shift to the bright side (right side). If the exposure compensation is applied on the negative side, the histogram will shift to the other side. Both ends of the histogram show a bright or dark area portion. It is impossible to restore these area with a computer later. Adjust the exposure if necessary and shoot again.

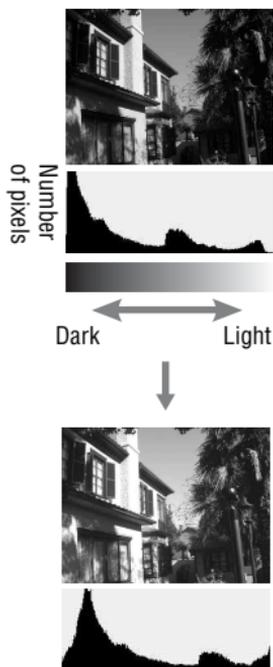

Rotating an image

1 Display the image you want to rotate, then press the  button.

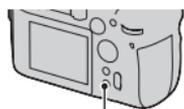

 button

2 Press the center of the multi-selector.

The image is rotated counter-clockwise. When you want to do another rotation, repeat step 2.

- Once you rotate the image, the image is played back in the rotated position, even if you turn off the power.

To return to the normal playback screen

Press the  button.

Note

- When you copy rotated images to a computer, “PMB” contained on the CD-ROM (supplied) can display the rotated images correctly. However, the images may not be rotated depending on the software.

Enlarging images

An image can be enlarged for closer examination. This is convenient to check the focus condition of a recorded image.

1 Display the image you want to enlarge, then press the **Q** button.

The center of the image is enlarged.

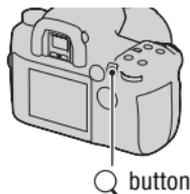

2 Scale up or down the image with the rear control dial.

3 Select the portion you want to enlarge with **▲/▼/◀/▶** on the multi-selector.

- Each time you press the center of the multi-selector, the screen changes between the enlarged screen and the whole screen.
- You can select an image with the front control dial at the same scaling.
- Each time you press the DISP button, the information on the screen is switched between on and off.

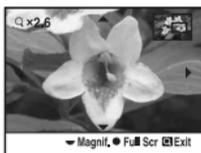

Enlarged playback screen

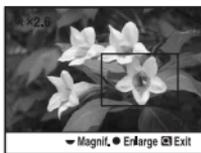

Entire screen

To cancel the enlarged playback

Press the **▶** or **Q** button.

Note

- For enlarged RAW images, the effect of the D-Range optimizer other than **D-R** (Standard) cannot be checked on the camera.

Scaling range

Image size	Scaling range
L	Approx. $\times 1.2 - \times 19$
M	Approx. $\times 1.2 - \times 14$
S	Approx. $\times 1.2 - \times 9.4$

Switching to the display of the image list

1 Press the button.

The screen changes to the index screen.

 button



2 Press the DISP button repeatedly to select the desired screen format.

- The screen changes in the following order: 9 images \rightarrow 25 images \rightarrow 4 images

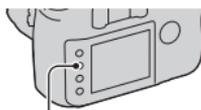

DISP button

To return to the single-image screen

Press the  button or the center of the multi-selector when you select the desired image.

To select a folder

- Select the folder bar with /  on the multi-selector, then press the center.
- Select the desired folder with / , then press the center of the multi-selector.

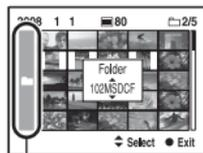

Folder bar

Checking the information of recorded images

Basic information display

 100-0003  FINE 

1/125 F3.5 ISO100
2008 1 1 10:37AM 3/7

Display	Indication
 	Memory card (23)
100-0003	Folder - file number (141)
	Protect (121)
DPOF3	DPOF set (121)
RAW cRAW RAW+J cRAW+J X.FINE FINE STD	Image quality (105)
           	Image size (104)/APS-C size (132)/Aspect ratio (104)
	Battery remaining warning (19)
1/125	Shutter speed (52)
F3.5	Aperture (51)
ISO100	ISO sensitivity (72)
2008 1 1 10:37AM	Date of recording

Display	Indication
3/7	File number/total number of images

Histogram display

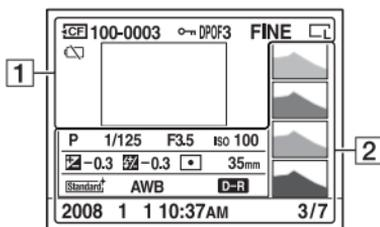

1

Display	Indication
	Memory card (23)
100-0003	Folder - file number (141)
	Protect (121)
DPOF3	DPOF set (121)
RAW cRAW RAW+J cRAW+J X.FINE FINE STD	Image quality (105)
	Image size (104)/APS-C size (132)/Aspect ratio (104)
	Battery remaining warning (19)

2

Display	Indication
	Histogram (91)
AUTO P A S M	Exposure mode (47, 49)
1/125	Shutter speed (52)
F3.5	Aperture (51)
ISO100	ISO sensitivity (72)

Display	Indication
-0.3	Exposure compensation (68)
-0.3	Flash compensation (71)
	Metering mode (67)
35mm	Focal length
	Creative Style (78)
AWB WB 5500K M1	White balance (Auto, Preset, Color temperature, Color filter, Custom) (73)
D-R	D-Range Optimizer (77)
2008 1 1 10:37AM	Date of recording
3/7	File number/total number of images

Deleting images (Delete)

Once you have deleted an image, you cannot restore it. Check whether you delete the image or not beforehand.

Note

- Protected images cannot be deleted.

Deleting the image that is currently displayed

- 1 Display the image you want to delete and press the  button.

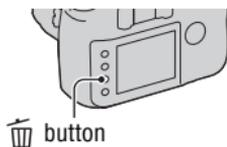

- 2 Select [Delete] with  on the multi-selector, then press the center of the multi-selector.

Deleting all the images in the folder

- 1 Press the  button.
- 2 Select the folder bar with  on the multi-selector.

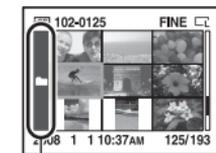

Folder bar

- 3 Press the center of the multi-selector, then select the folder you want to delete with /.
- 4 Press the  button.

5 Select [Delete] with ▲ on the multi-selector, then press the center of the multi-selector.

Viewing images on a TV screen

- 1 Turn off both your camera and the TV, and connect the camera to the TV.

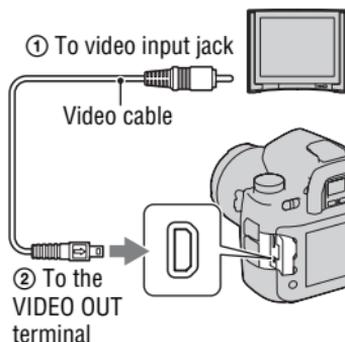

- 2 Turn on the TV and switch the input.

- See also the operating instructions supplied with the TV.

- 3 Turn on the camera, and press the  button.

Images shot with the camera appear on the TV screen.

Select the desired image with   on the multi-selector.

- The LCD monitor on the rear of the camera does not turn on.

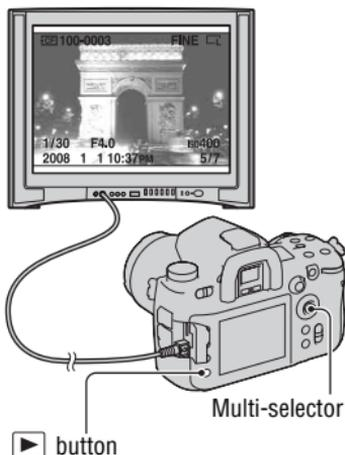

To use your camera abroad

It may be necessary to switch the video signal output to match that of your TV system (page 125).

To view images using the Wireless Remote Commander

Connecting the camera to a TV and turning to the playback mode allows you to play back images using the RMT-DSLR1 Wireless Remote Commander (sold separately). Most of the buttons on the Wireless Remote Commander have the same functions as the buttons on the camera.

On TV color systems

If you want to view images on a TV screen, you need a TV with a video input jack and the video cable. The color system of the TV must match that of your digital still camera. Check the following lists for the TV color system of the country or region where the camera is used.

NTSC system

Bahama Islands, Bolivia, Canada, Central America, Chile, Colombia, Ecuador, Jamaica, Japan, Korea, Mexico, Peru, Surinam, Taiwan, the Philippines, the U.S.A., Venezuela, etc.

PAL system

Australia, Austria, Belgium, China, Czech Republic, Denmark, Finland, Germany, Holland, Hong Kong, Hungary, Italy, Kuwait, Malaysia, New Zealand, Norway, Poland, Portugal, Singapore, Slovak Republic, Spain, Sweden, Switzerland, Thailand, United Kingdom, etc.

PAL-M system

Brazil

PAL-N system

Argentina, Paraguay, Uruguay

SECAM system

Bulgaria, France, Guiana, Iran, Iraq, Monaco, Russia, Ukraine, etc.

Viewing images higher image quality

If you are using an HDTV equipped with an HDMI connector, you can view images higher image quality by using an HDMI cable (sold separately).

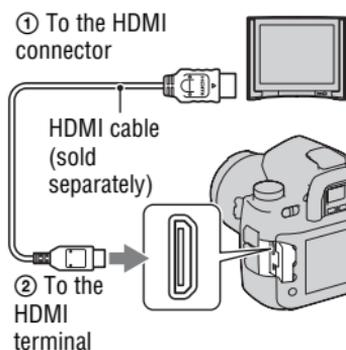

To change the type of the HDMI output signal

The output signal from this camera is determined automatically according to a connected TV, other signals, however, may make the image clearer, depending on the subject (page 125).

Notes

- Use an HDMI cable with the HDMI logo.
- Use an HDMI mini connector on one end (for the camera), and a connector suitable for connection to your TV on the other end.
- By connecting your camera to Sony's VIDEO-A compatible TV using an HDMI cable, TV sets suitable image quality for viewing still picture automatically. Please refer to the operating instructions of Sony's VIDEO-A compatible TV for more details.
- Some devices may not work properly.
- Do not connect the output connector of the device with the HDMI terminal on the camera. This may cause a malfunction.

On "PhotoTV HD"

This camera is compatible with the "PhotoTV HD" standard.

By connecting Sony's PhotoTV HD-compatible devices using an HDMI cable, whole new world of photos can be enjoyed in breathtaking Full HD quality.

"PhotoTV HD" allows for a highly-detailed, photo-like expression of subtle textures and colors.

Menu function list

This section describes how to set up the function using the MENU button. After pressing the MENU button, operate the multi-selector, following the instructions in the operation guide (page 45).

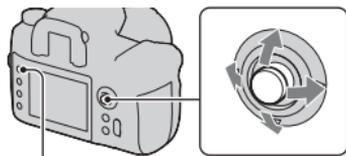

MENU button

Recording menu (pages 104 to 112)

 1	Image size Aspect ratio Quality D-RangeOptimizer Custom button Creative Style Color Space
--	---

 2	Flash mode Flash control Flash compens. Exposure step ISO Auto Range
---	--

 3	AF-A setup AF area Priority setup AF illuminator AF w/ shutter Long exp.NR High ISO NR
--	--

 4	Memory Rec mode reset
---	--------------------------

Custom menu (pages 113 to 119)

 1	AF/MF button AF/MF control AF drive speed AF area disp. FocusHoldButton Auto review Preview Function
--	--

 2	AEL button Ctrl dial setup Dial exp.comp Ctrl dial lock Button ops. Release w/oCard Rec.info.disp.
---	--

 3	Exp.comp.set Bracket order Custom reset
--	---

Playback menu (pages 120 to 123)

 1	Delete Format Protect DPOF setup <ul style="list-style-type: none">• Date imprint• Index print PlaybackDisplay
---	--

 2	Slide show <ul style="list-style-type: none">• Interval
---	---

Setup menu (pages 124 to 134)

 1	LCD brightness Info.disp.time Power save Video output HDMI output  Language Date/Time setup
---	--

 2	Memory card File number Folder name Select folder <ul style="list-style-type: none">• New folder USB connection <ul style="list-style-type: none">• MassStrg.card
---	--

 3	Menu start Delete confirm. Audio signals Cleaning mode AF Micro Adj. <ul style="list-style-type: none">• amount Focusing Screen
---	---

 4	APS-C size capt. Reset default
---	-----------------------------------

Recording menu 1

Image size

[Aspect ratio]: [3:2]

L:24M	6048 × 4032 pixels
M:13M	4400 × 2936 pixels
S:6.1M	3024 × 2016 pixels

[Aspect ratio]: [16:9]

L:21M	6048 × 3408 pixels
M:11M	4400 × 2472 pixels
S:5.2M	3024 × 1704 pixels

[APS-C size capt.]: [On]

L:11M	3984 × 2656 pixels
M:5.6M	2896 × 1928 pixels
S:2.6M	1984 × 1320 pixels

Notes

- When you select a RAW format with [Quality], the image size of the RAW image corresponds to L. This size is not displayed on the LCD monitor.
- When attaching a DT lens, [APS-C size capt.] is automatically selected.

Aspect ratio

3:2	A normal ratio.
16:9	An HDTV ratio.

Quality

RAW (RAW)	File format: RAW (raw data) This format is not achieved by digital processing. Select this format to process images on a computer for professional purposes. <ul style="list-style-type: none">• The image size is fixed to the maximum size. The image size is not displayed on the LCD monitor.
cRAW* (cRAW)	
RAW & JPEG (RAW+J)	File format: RAW (raw data) + JPEG A RAW image and a JPEG image are created at the same time. This is suitable when you need two image files, a JPEG for viewing, and a RAW for editing. The image quality is fixed to [Fine].
cRAW & JPEG* (cRAW+J)	
Extra fine (X,FINE)	File format: JPEG The image is compressed in the JPEG format when recorded. The higher the compression rate, the smaller the file size. This will allow more files to be recorded in one memory card, but the image quality will be lower.
Fine (FINE)	
Standard (STD)	

*“c” of “cRAW” means “compressed.” The data is compressed up to about 60 to 70% compared to an image not compressed. Use this setting when you want to increase the number of images that can be taken.

Note

- For details on the number of images that can be taken when the image quality is changed, see page 31.

About RAW images

You need the “Image Data Converter SR” software included on the CD-ROM (supplied) in order to open a RAW image recorded on this camera. With this software, a RAW image can be opened and converted to a common format, such as JPEG or TIFF, and its white balance, color saturation, contrast, etc., can be readjusted.

- Recording a RAW image entails the following limitation.
 - The RAW image cannot be printed using a DPOF (print) designated printer or a PictBridge compliant printer.
- You cannot verify the effects of D-Range Optimizer other than those of **D-R** (Standard) if you play back and enlarge an image recorded in RAW format.

D-RangeOptimizer

For details, see page 77.

Custom button

You can assign a function of your choosing to the C button. In the default setting, [Creative Style] is assigned to the C button.

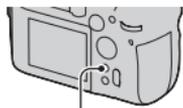

C button

The functions you can register

AF lock/AF/MF control/Optical Preview/IntelligentPrev./ISO/White balance/Exposure comp./Flash compens./Drive mode/AF area/Image size/Quality/Creative Style/D-RangeOptimizer/Flash mode/Memory

Creative Style

For details, see page 78.

Color Space

The way colors are represented with combinations of numbers or the range of color reproduction is called “color space.” You can change the color space, depending on your purpose.

sRGB	This is the standard color space of the digital camera. Use sRGB in normal shooting, such as when you intend to print out the images without any modification.
Adobe RGB	This has a wide range of color reproduction. When a large part of the subject is vivid green or red, Adobe RGB is effective. <ul style="list-style-type: none">• The file name of the image starts with “_DSC.”

Notes

- Adobe RGB is for applications or printers that support color management and DCF2.0 option color space. Using some applications or printers that do not support them may result in or print images that do not reproduce faithful color.
- When displaying images that were recorded with Adobe RGB on the camera or non-Adobe RGB-compliant devices, the images are displayed with low saturation.

Recording menu 2

Flash mode

For details, see page 64.

Flash control

You can select the flash control mode to set the amount of flash light.

ADI flash	This method controls the lighting of the flash, factoring in the focus distance information and light metering data from the pre-flash. This method enables an accurate flash compensation with virtually no effect from the reflection off the subject.
Pre-flash TTL	This method controls the amount of flash light depending on the data only from pre-flash light metering. This method is susceptible to the reflection off the subject.

ADI: Advanced Distance Integration

TTL: Through the lens

- When [ADI flash] is selected, using a lens that is provided with a distance encoder feature can perform more accurate flash compensation by using more accurate distance information.

Notes

- When the distance between the subject and the flash cannot be determined (wireless flash shooting, shooting with an off-camera flash using a cable, shooting with a macro twin flash, etc.), the camera automatically selects Pre-flash TTL mode.
- Select [Pre-flash TTL] in the following cases, as the camera cannot perform flash compensations with ADI flash.
 - A wide panel is attached to the HVL-F36AM flash.
 - A diffuser is used for flash shooting.
 - A filter with an exposure factor, such as an ND filter, is used.
 - A close-up lens is used.
- ADI flash is only available in combination with a lens that is provided with a distance encoder. To determine if the lens is equipped with a distance encoder, refer to the operating instructions supplied with the lens.

Flash compens.

For details, see page 71.

Exposure step

You can select a compensation increment for shutter speed, aperture, and exposure.

0.5 EV	Changes in 1/2 EV steps.
0.3 EV	Changes in 1/3 EV steps.

ISO Auto Range

400 – 1600	Sets the range to 400 – 1600.
400 – 800	Sets the range to 400 – 800.
200 – 1600	Sets the range to 200 – 1600.
200 – 800	Sets the range to 200 – 800.
200 – 400	Sets the range to 200 – 400.

Recording menu 3

AF-A setup

For details, see page 61.

AF area

For details, see page 58.

Priority setup

Select a setting for shutter release.

AF	The shutter cannot be released when the focus is not confirmed.
Release	The shutter can be released even when the focus is not confirmed. Select this setting if the shooting opportunity takes precedence.

Note

- The shutter can be released regardless of the setting in the manual focus, even if the focus is not achieved.

AF illuminator

You can set the AF illuminator to on or off. For details on AF illuminator, see page 60.

Auto	Automatically fills the AF illuminator if necessary.
Off	Does not fill the AF illuminator.

Note

- When [AF illuminator] is set to [Off], the AF illuminator of the flash (sold separately) does not function.

AF w/ shutter

In the default setting, adjusting the focus is carried out by pressing the shutter button halfway down. You can deactivate this action.

On	Adjusts the focus by pressing the shutter button halfway down.
Off	Does not adjust the focus by pressing the shutter button halfway down. You can adjust the focus by pressing the center of the multi-selector. This is convenient when shooting continuously at the same focus position.

Long exp.NR

Long exposure makes noise conspicuous. When the shutter speed is one second or slower, noise reduction is activated to reduce the grainy noise that is common in long exposures.

On	When the shutter speed is one second or slower, the noise reduction process is performed for the duration that the shutter was open. You cannot take the next picture until the process is over. This is suitable when the image quality takes precedence.
Off	This mode does not perform noise reduction. This is suitable when timing of shooting takes precedence.

Note

- Noise reduction is not performed on continuous shooting or continuous bracket even when it is set to [On].

High ISO NR

When shooting with the ISO set at 1600 or above, the camera reduces the noise that becomes more noticeable when the camera sensitivity is high.

High	When [High] is selected, the noise reduction works more effectively. When you give priority to the details of a subject, select [Low].
Normal	
Low	
Off	Does not reduce noise.

Note

- The speed of continuous shooting becomes slower when set to [High].

Recording menu 4

Memory

For details, see page 89.

Rec mode reset

You can reset the main functions of the recording mode when the mode dial is set to P, A, S, or M.

The items to be reset are as follows.

Items	Reset to (default setting)
Exposure comp. (68)	±0.0
Drive mode (81)	Single-shot adv.
White balance (73)	AWB
ColorTemperature/Color filter (74)	5500K, Color filter 0
Custom white balance (75)	5500K
ISO (72)	AUTO
Image size (104)	L:24M
Aspect ratio (104)	3:2
Quality (105)	Fine
D-RangeOptimizer (77)	Off
Custom button (106)	Creative Style
Creative Style (78)	Standard
Color Space (106)	sRGB
Flash mode (64)	Fill-flash
Flash control (107)	ADI flash
Flash compens. (71)	±0.0
Exposure step (108)	0.3 EV
ISO Auto Range (108)	200 – 800
AF-A setup (109)	AF-A
AF area (58)	Wide
Priority setup (109)	AF
AF illuminator (60)	Auto

Items	Reset to (default setting)
AF w/ shutter (110)	On
Long exp.NR (110)	On
High ISO NR (110)	Normal

⚙️ Custom menu 1

AF/MF button

AF/MF control	Uses the button for switching the auto focus and manual focus (page 62).
AF lock	Uses the button as the AF lock button. Press the shutter button to take pictures while holding the AF/MF button down.

AF/MF control

When [AF/MF button] is set to [AF/MF control], you can change how you operate the AF/MF button.

Hold	AF and MF are switched only while the button is held down.
Toggle	Press and release the button to switch between AF and MF. The setting is maintained until you press the button again.

AF drive speed

You can select the speed of focusing when the auto focus is activated.

Fast	Confirms the focus quickly.
Slow	Confirms the focus slowly. Has a higher probability of confirming the focus when shooting a subject using macro shooting feature.

AF area disp.

When the focus is being adjusted, the local AF area in focus is briefly illuminated in red. You can change the duration of illumination or turn off the illumination.

0.6 sec	The local AF area is illuminated for 0.6 seconds.
0.3 sec	The local AF area is illuminated for 0.3 seconds.
Off	The local AF area is illuminated only when the multi-selector is pressed.

FocusHoldButton

If you use a lens equipped with a focus hold button, you can change the function of the button to preview a shot.

Focus hold	Uses the button as the focus hold button.
Optical Preview	Uses the button as the optical preview button.
IntelligentPrev.	Uses the button as the intelligent preview button.

Auto review

After an image is recorded, you can display it on the LCD monitor. You can change the display time.

10 sec	Displays the image on the LCD monitor for the amount of time you selected.
5 sec	
2 sec	
Off	Deactivates auto review.

Note

- In auto review, the image will not be displayed in the vertical position even if you shot the image in a vertical position (page 122).

Preview Function

You can select the preview function. For details on preview function, see page 87.

Intelligent	Uses the Intelligent preview function.
Optical Preview	Uses only the Optical preview function.

⚙ Custom menu 2

AEL button

The function and the mode of operation of the AEL button can be changed.

AEL hold	The camera locks the measured exposure value. Select from the following two options: Holding the value while the AEL button is pressed ([AEL hold]) or holding the value until the AEL button is pressed again ([AEL toggle]). This is useful when you want to keep regular exposures on multiple images.
AEL toggle	
<input type="checkbox"/> AEL hold	The camera temporarily performs spot metering and locks the measured exposure value. Select from the following two options: Holding the value while the AEL button is pressed ([<input type="checkbox"/> AEL hold]) or holding the value until the AEL button is pressed again ([<input type="checkbox"/> AEL toggle]). This is useful when you want to temporarily perform spot metering.
<input type="checkbox"/> AEL toggle	

Notes

- While the exposure value is locked, ***** appears on the LCD monitor and in the viewfinder. Be careful not to reset the setting.
- The “Hold” and “Toggle” settings affect the Manual Shift (page 54) in the manual exposure mode.

Ctrl dial setup

When the mode dial is set to M (Manual exposure) or P (Program Shift), you can switch the functions of the front () and rear () control dials from the shutter speed or aperture.

 SS  F/no.	Adjusts the shutter speed with the front control dial and adjusts the aperture with the rear control dial.
 F/no.  SS	Adjusts the aperture with the front control dial and adjusts the shutter speed with the rear control dial.

Dial exp.comp

You can compensate the exposure with the front control dial (☀️) or rear control dial (🌑).

Off	Does not compensate the exposure with the dials.
☀️ Front dial	Compensates the exposure with the front control dial.
🌑 Rear dial	Compensates the exposure with the rear control dial.

For example, when [Ctrl dial setup] is set to [☀️SS 🌑F/no.], the functions of the front and rear control dials are as follows:

Exposure Mode		Off	☀️ Front dial	🌑 Rear dial
P	Front control dial	P _S shift	Exp. comp	P _S shift
	Rear control dial	P _A shift	P _A shift	Exp. comp
A	Front control dial	Aperture	Exp. comp	Aperture
	Rear control dial	Aperture	Aperture	Exp. comp
S	Front control dial	Shutter speed	Exp. comp	Shutter speed
	Rear control dial	Shutter speed	Shutter speed	Exp. comp
M	Front control dial	Shutter speed	Shutter speed	Shutter speed
	Rear control dial	Aperture	Aperture	Aperture

Ctrl dial lock

When the exposure value is not displayed, you can lock the front and rear control dials to deactivate them.

On	The front and rear control dial function only when the shutter speed and the aperture are displayed.
Off	The front and rear control dial function at all times.

Button ops.

In the default setting, pressing the ISO button, WB button, DRIVE button,  button, or C button will put the exclusive screen on the display. You can choose to have the Quick Navi screen (page 46) displayed instead.

Exclusive disp	Displays an exclusive screen for each mode.
Quick Navi	Displays the Quick Navi screen of the mode selected at the time.

Note

- Even if [Quick Navi] is selected, the exclusive screen will be displayed when no item is applicable on the enlarged display screen.

Release w/oCard

You can set the shutter lock to keep the shutter from releasing when no memory card is inserted in the camera.

Enable	The shutter can be released when no memory card is inserted in the camera.
Disable	The shutter cannot be released when no memory card is inserted in the camera.

Rec.info.disp.

You can set the recording information display to rotate when the camera is in a vertical position.

Auto rotate	The display rotates to a vertical position (page 40).
Horizontal	The display does not rotate.

Custom menu 3

Exp.comp.set

You can select a method for exposure compensation when a flash is used.

Ambient&flash	Exposure compensation is performed on both the ambient light range (the background that the flash light does not reach) and the flash light range. <ul style="list-style-type: none">• Values that change: shutter speed, aperture, ISO (only in AUTO mode), amount of flash light• Values that do not change: none
Ambient only	By fixing the amount of flash light, you can limit the effect of exposure compensation to the background that is illuminated only by ambient light (light other than the flash). <ul style="list-style-type: none">• Values that change: shutter speed, aperture, ISO (only in AUTO mode)• Values that do not change: amount of flash light

- With the flash compensation, you can limit the compensation to flash light range by fixing the exposure of ambient light range that the flash light does not reach (page 71).

Bracket order

The order in bracket shooting (page 83) can be selected. This does not apply to DRO advanced bracket.

0 → - → +	Uses 0 EV in shooting the first picture which presents the best shooting opportunity. Example: ±0 EV → -0.3 EV → +0.3 EV → -0.7 EV → +0.7 EV
- → 0 → +	Ordered from low to high exposure. Example: -0.7 EV → -0.3 EV → ±0 EV → +0.3 EV → +0.7 EV

Custom reset

You can reset the items of the Custom menu.

The items to be reset are as follows.

Items	Reset to (default setting)
AF/MF button (113)	AF/MF control
AF/MF control (113)	Hold
AF drive speed (113)	Fast
AF area disp. (113)	0.3 sec
FocusHoldButton (114)	Focus hold
Auto review (114)	2 sec
Preview Function (87)	Intelligent
AEL button (115)	AEL hold
Ctrl dial setup (115)	 SS  F/no.
Dial exp.comp (116)	Off
Ctrl dial lock (116)	Off
Button ops. (117)	Exclusive disp
Release w/oCard (117)	Enable
Rec.info.disp. (117)	Auto rotate
Exp.comp.set (118)	Ambient&flash
Bracket order (118)	0 → - → +

Playback menu 1

Delete

You can delete multiple images. Once you have deleted an image, you cannot restore it. Check whether you delete the image or not beforehand.

Marked images	Deletes the selected images. ① Select the images you want to delete with ◀/▶ on the multi-selector, then press the center of the multi-selector. (To cancel a selection, press the center again.) To delete other images, repeat this step. ② Press the MENU button. After a message appears, select [Delete] with ▲ on the multi-selector, then press the center of the multi-selector.
All images	Deletes all the images in the memory card. After a message appears, select [Delete] with ▲ on the multi-selector, then press the center of the multi-selector.

Note

- Protected images cannot be deleted.

Format

Formats the memory card. Note that formatting irrevocably erases all data on a memory card, including protected images.

After a message appears, select [OK] with ▲ on the multi-selector, then press the center of the multi-selector.

Notes

- During the format, the access lamp lights up. Do not eject the memory card while the lamp is lit.
- Format the memory card using the camera. If you format it on a computer, the memory card may not be usable with the camera, depending on the format type used.
- Formatting may take several minutes depending on the memory card.
- You cannot format “Memory Stick Duo” media that are inserted into the CF card insertion slot using an adaptor.

Protect

You can protect images against accidental erasure.

Marked images	Protects selected images or cancels the protection of the selected images. ① Select the image you want to protect with ◀/▶ on the multi-selector, then press the center of the multi-selector. (To cancel a selection, press the center again.) To protect other images or cancel the protection of other images, repeat this step. ② Press the MENU button. After a message appears, select [OK] with ▲ on the multi-selector, then press the center of the multi-selector.
All images	Protects all the images or cancels the protection of all the images in the memory card. After a message appears, select [OK] with ▲ on the multi-selector, then press the center of the multi-selector.
Cancel all	

DPOF setup

Using the camera, you can specify the images and the number of images to print before you print images at a shop or with your printer.

DPOF specifications are left with images after printing.

Marked images	Specifies/unspecifies DPOF on the selected images. ① Select the image you want to specify DPOF with ◀/▶ on the multi-selector, then select the number of sheets with the rear control dial. (To unspecify DPOF, set the number to "0.") To specify/unspecify DPOF on other images, repeat this step. ② Press the MENU button. After a message appears, select [OK] with ▲ on the multi-selector, then press the center of the multi-selector.
All images	To specify/unspecify DPOF on all the images in the memory card. When [All images] is selected, set the number of images with ▲/▼ on the multi-selector, then press the center of the multi-selector. After a message appears, select [OK] with ▲ on the multi-selector, then press the center of the multi-selector.
Cancel all	

Notes

- You cannot specify DPOF on RAW images.
- You can specify any number up to 9.

Date imprint

You can date images when printing them. The position of the date (inside or outside the image, character size, etc.) depends on your printer.

On	Imposes the date.
Off	Does not impose the date.

Note

- This function may not be provided, depending on the printer.

Index print

You can create an index print of all the images in the memory card.

Create index	Specifies an index print.
Delete index	Does not specify an index print.

Notes

- The number of images that can be printed on one sheet and the format depend on the printer. RAW images do not print in index print.
- The images you shoot after setting the index print are not included in the index print. It is recommended that you create the index print just before printing it.

PlaybackDisplay

When you play back an image recorded in the portrait position, the camera detects the orientation of the image and automatically displays it in the correct position.

Auto rotate	Displays the image in the portrait position, if required.
Manual rotate	Displays all images in the landscape position.

Playback menu 2

Slide show

Repeatedly plays back the recorded images in the memory card. You can view the previous/next image with ◀/▶ on the multi-selector.

To pause the slide show

Press the center of the multi-selector. Pressing again starts the slide show again.

To end in the middle of the slide show

Press the MENU button.

Interval

30 sec	The image switches at the selected interval time.
10 sec	
5 sec	
3 sec	
1 sec	

Setup menu 1

LCD brightness

You can adjust the brightness of the LCD monitor.

Adjust the brightness with ◀/▶ on the multi-selector, then press the center of the multi-selector.

- On the recording information or playback screen, you can adjust the brightness by pressing the DISP button a little longer.

Info.disp.time

1 min	Displays for the amount of time you select.
30 sec	
10 sec	
5 sec	

Note

- Regardless of the setting in this menu, the eyepiece sensors below the viewfinder turn off the LCD monitor while you are looking into the viewfinder.

Power save

You can set the time to turn the camera to the power saving mode (Power save). Pressing the shutter button halfway down returns the camera to the shooting mode.

30 min	The camera turns to power save mode after the selected time has elapsed.
10 min	
5 min	
3 min	
1 min	

Note

- Regardless of the setting here, the camera turns to power save mode after 30 minutes when the camera is connected to a TV or the drive mode is set to  (Remote Commander).

Video output

Sets the video signal output according to the TV color system of the connected video equipment. Different countries and regions use different TV color systems. If you want to view images on a TV screen, check page 100 for the TV color system of the country or region where the camera is used.

NTSC	Sets the video output signal to NTSC mode (e.g., for the USA, Japan).
PAL	Sets the video output signal to PAL mode (e.g., for Europe).

HDMI output

When you connect the camera with an HDTV using an HDMI terminal (page 101), the output signal from this camera is determined automatically. When displaying images recorded with a camera, other signals may make the image clearer, depending on the subject. You can make the following changes.

HD(1080i)prior.	Prioritizes HD (1080i) signal output.
HD(720p)prior.	Prioritizes HD (720p) signal output.
SD priority	Prioritizes SD (standard) signal output.

Language

Select the language to be used to display the menu items, warning, and messages.

Date/Time setup

Sets the date and time again.
For details, see page 27.

Setup menu 2

Memory card

You can select the types of memory cards that you use for recording or playback.

Memory Stick	Uses the “Memory Stick Duo” media for recording or playback.
CompactFlash	Uses the CF card/Microdrive for recording or playback.

File number

Selects the method used to assign file numbers to images.

Series	The camera does not reset numbers and assigns numbers to files in sequence until the number reaches “9999.”
Reset	The camera resets numbers in the following cases and assigns numbers to files from “0001.” When the recording folder contains a file, a number one higher than the largest number is assigned. <ul style="list-style-type: none">– When the folder format is changed.– When all the images in the folder are deleted.– When the memory card is replaced.– When the memory card is formatted.

Folder name

Selects the folder name format.

The recorded images are stored in the automatically-created folder in the DCIM folder on the memory card.

Standard form	The folder name format is as follows: folder number + MSDCF. Example: 100MSDCF
Date form	The folder name format is as follows: folder number + Y (the last digit)/MM/DD. Example: 10080405 (Folder name: 100, date: 04/05/2008)

Select folder

When a standard form folder is selected and there are two or more folders, you can select the recording folder to be used to record images.

Select the desired folder with ▲/▼ on the multi-selector, then press the center of the multi-selector.

Note

- You cannot select the folder when you are setting [Date form].

New folder

You can create a folder in a memory card for recording images. A new folder is created with a number incremented one higher than the largest number currently used, and the folder becomes the current recording folder.

USB connection

Selects the USB mode to be used when connecting the camera to a computer, etc., using a USB cable.

Mass Storage	Used for copying images to the computer. The camera is recognized as a USB mass storage device.
PTP	Prints the images with a PictBridge compliant printer or copies images to PTP (Picture Transfer Protocol) compliant devices. <ul style="list-style-type: none">• For details on printing with a PictBridge compliant printer, see page 150.
Remote PC	Using “Remote Camera Control” contained on the CD-ROM (supplied), you can operate some functions of the camera (such as shooting) from a computer, store the recorded images to a computer, etc.

MassStrg.card

When “Memory Stick Duo” media and a CF card are both inserted in the camera during mass storage connections, you can select the displayed method on a PC.

Both cards	Displays both the “Memory Stick Duo” media and CF card/ Microdrive. This is supported by a PC running Windows 2000 SP3, or a later version of OS.
Selected card	Displays only the card selected with [Memory card].

Setup menu 3

Menu start

You can select the default screen when you press the MENU button.

Top	Displays the  1 or  1 menu screen first.
Previous	Displays the previously selected menu screen first.

Delete confirm.

You can select the default item of a confirmation screen when deleting the images or the folders.

"Delete" first	[Delete] is selected by default.
"Cancel" first	[Cancel] is selected by default.

Audio signals

Selects the sound produced when the focus is confirmed, during self-timer countdown, etc.

On	Turns on the sound.
Off	Turns off the sound.

Cleaning mode

For details, see page 34.

AF Micro Adj.

You can finely adjust the focus of each lens.

Perform this operation only when needed. Note that you may not be able to properly focus on a subject if you have made a poor adjustment.

On	Registers the adjustment value of the attached lens or focuses on a subject using the registered value. Adjustment values are set between -20 to +20.
Off	Does not perform AF fine adjustment.
Clear	Clears the values of all the registered lenses. After a message appears, select [OK] with ▲ on the multi-selector, then press the center of the multi-selector.

amount

You can register adjusted values of [AF Micro Adj.].

Select the desired value with ▲/▼ on the multi-selector, then press the center of the multi-selector.

Notes

- When [AF Micro Adj.] is not set to [On], you cannot register an adjustment value.
- By shifting the value toward +, the focus point shifts toward the background, and by shifting it toward -, the point shifts toward the foreground. Decide the value by reference to the result of a test shooting.
- We recommend that you decide the value under actual shooting conditions.
- When you attach a lens that is registered on the camera, the registered value is displayed. When you attach an unregistered lens, "±0" is displayed. If "-" is displayed as the value, then a total of 30 lenses have been registered. When you want to register a new lens, attach a lens for which you can delete its registered value, and set that value to "±0," or reset the values of all the lenses with [Clear].
- If you perform AF fine adjustment with a lens of other manufacturers, the adjustment values of Sony, Minolta, and Konica Minolta lenses may be affected. Do not use this function with any lens of other manufacturers.
- You cannot individually perform AF fine adjustment when using the Sony, Minolta, and Konica Minolta lenses that have the same specifications.

Focusing Screen

You can change the focusing screen to Type L (sold separately) or Type M (sold separately) according to your purpose. Select the appropriate setting for the type of screen after changing the screen itself.

Type G	Standard focusing screens (the default one).
Type M	Focusing screens that make it easier to check the peak of the focus and approximate sharpness. This is suitable for a brighter lens (F1.4 to 2.8).
Type L	Focusing screens that are equipped with a grid. The brightness of the viewfinder is the same as that of the G type.

Notes

- If the type of screen is not properly set, you cannot measure the light properly.
- For details on how to change the focusing screen, refer to the operating instructions supplied with the focusing screen.

Setup menu 4

APS-C size capt.

Captures an image in the area equivalent to the APS-C size.
Decide on composition using  (APS-C size area) in the viewfinder as a guide. [Aspect ratio] is set to [3:2].

On	Shoots an image in the APS-C size area.
Off	Shoots an image in the normal size area.

Reset default

You can reset the main functions of the camera.
The items to be reset are as follows.

Items	Reset to (default setting)
Recording information display (39)	Detailed display
Exposure compensation (68)	±0.0
Drive mode (81)	Single-shot adv.
White balance (73)	AWB (Auto white balance)
ColorTemperature/Color filter (74)	5500K, Color filter 0
Custom white balance (75)	5500K
ISO (72)	AUTO
Playback display (90)	Single-image screen (with recording data)

Recording menu

Items	Reset to (default setting)
Image size (104)	L:24M
Aspect ratio (104)	3:2
Quality (105)	Fine
D-RangeOptimizer (77)	Off
Custom button (106)	Creative Style
Creative Style (78)	Standard
Color Space (106)	sRGB
Flash mode (64)	Autoflash or Fill-flash

Items	Reset to (default setting)
Flash control (107)	ADI flash
Flash compens. (71)	±0.0
Exposure step (108)	0.3 EV
ISO Auto Range (108)	200 – 800
AF-A setup (109)	AF-A
AF area (58)	Wide
Priority setup (109)	AF
AF illuminator (60)	Auto
AF w/ shutter (110)	On
Long exp.NR (110)	On
High ISO NR (110)	Normal

Custom menu

Items	Reset to (default setting)
AF/MF button (113)	AF/MF control
AF/MF control (113)	Hold
AF drive speed (113)	Fast
AF area disp. (113)	0.3 sec
FocusHoldButton (114)	Focus hold
Auto review (114)	2 sec
Preview Function (87)	Intelligent
AEL button (115)	AEL hold
Ctrl dial setup (115)	 SS  F/no.
Dial exp.comp (116)	Off
Ctrl dial lock (116)	Off
Button ops. (117)	Exclusive disp
Release w/oCard (117)	Enable
Rec.info.disp. (117)	Auto rotate
Exp.comp.set (118)	Ambient&flash
Bracket order (118)	0 → - → +

Playback menu

Items	Reset to (default setting)
DPOF setup – Date imprint (121)	Off
PlaybackDisplay (122)	Auto rotate
Slide show – Interval (123)	3 sec

Setup menu

Items	Reset to (default setting)
LCD brightness (124)	±0
Info.disp.time (124)	5 sec
Power save (124)	3 min
HDMI output (125)	HD(1080i)prior.
File number (126)	Series
Folder name (126)	Standard form
USB connection (127)	Mass Storage
MassStrg.card (128)	Selected card
Menu start (129)	Top
Delete confirm. (129)	“Cancel” first
Audio signals (129)	On
AF Micro Adj. (130)	Off
APS-C size capt. (132)	Off

Copying images to your computer

This section describes how to copy images in a memory card to a computer connected using a USB cable.

Recommended computer environment

The following environment is recommended for a computer connected to the camera to import images.

■ Windows

OS (pre-installed): Microsoft Windows 2000 Professional SP4/ Windows XP*¹ SP3/Windows Vista*² SP1

- Operation is not assured in an environment based on an upgrade of the operating systems described above or in a multi-boot environment.

*1 64-bit editions and Starter (Edition) are not supported.

*2 Starter (Edition) is not supported.

USB jack: Provided as standard

■ Macintosh

OS (pre-installed): Mac OS X (v10.1.3 – v10.5)

USB jack: Provided as standard

Notes on connecting your camera to a computer

- Operations are not guaranteed for all the recommended computer environments mentioned above.
- If you connect two or more USB devices to a single computer at the same time, some devices, including your camera, may not operate, depending on the types of USB devices you are using.
- Operations are not guaranteed when using a USB hub or an extension cable.
- Connecting your camera using a USB interface that is compatible with Hi-Speed USB (USB 2.0 compliant) allows advanced transfer (high speed transfer) as this camera is compatible with Hi-Speed USB (USB 2.0 compliant).
- When your computer resumes from a suspend or sleep mode, communication between your camera and your computer may not recover at the same time.

Stage 1: Connecting the camera and your computer

1 Insert a memory card with recorded images into the camera.

2 Insert the sufficiently charged battery pack in the camera, or connect the camera to a wall outlet (wall socket) with the AC Adaptor/charger (sold separately).

- When you copy images to your computer using insufficient battery pack, copying may fail or image data may become corrupted if the battery pack shuts down too soon.

3 Turn on the camera and the computer.

4 Check that [USB connection] in  2 is set to [Mass Storage] (page 127).

5 Connect the camera and your computer.

- The AutoPlay wizard appears on the desktop.

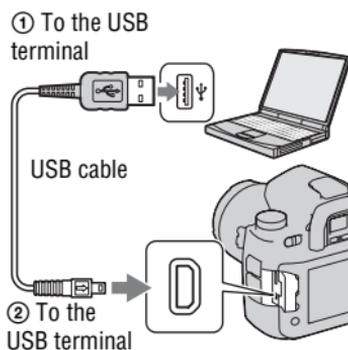

Stage 2: Copying images to a computer

For Windows

This section describes an example of copying images to a “Documents” (For Windows XP: “My Documents”) folder.

1 Click [Open folder to view files] (For Windows XP: [Open folder to view files] → [OK]) as the wizard screen appears automatically on the desktop.

- When the wizard screen does not appear, click [Computer] (For Windows XP: [My Computer]) → [Removable Disk].



2 Double-click [DCIM].

- In that case, you can also import images using “PMB.”

3 Double-click the folder where the image files you want to copy are stored.

Then, right-click an image file to display the menu and click [Copy].

- On the storage destination of the image files, see page 141.



4 Double-click the [Documents] folder. Then, right-click on the “Documents” window to display the menu and click [Paste].

The image files are copied to the “Documents” folder.

- When an image with the same file name exists in the copy destination folder, the overwrite confirmation message appears. When you overwrite an existing image with a new one, the original file data is deleted. To copy an image file to the computer without overwriting, change the file name to a different name and then copy the image file. However, note that if you change the file name, you may not be able to play back that image with your camera (page 141).



For Macintosh

1 Double-click the newly recognized icon → [DCIM] → the folder where the images you want to copy are stored.

2 Drag and drop the image files to the hard disk icon.

The image files are copied to the hard disk.

■ For Windows

Double-click  on the tasktray, then click  (USB Mass Storage Device) → [Stop]. Confirm the device on the confirmation window, then click [OK].

The device is disconnected.

■ For Macintosh

Drag and drop the drive icon or the icon of the memory card to the “Trash” icon.

The camera is disconnected from the computer.

Image file storage destinations and file names

The image files recorded with your camera are grouped as folders on the memory card.

Example: viewing folders on Windows Vista

- A** Folders containing image data recorded using this camera. (The first three digits show the folder number.)
- B** You can create a folder by date form (page 126).
- You cannot record/play back any images in the “MISC” folder.
- Image files are named as follows. □□□□ (file number) stands for any number within the range from 0001 to 9999. The numerical portions of the name of a RAW data file and its corresponding JPEG image file are the same.
 - JPEG files: DSC0□□□□.JPG
 - JPEG files (Adobe RGB):
_DSC□□□□.JPG
 - RAW data file (other than Adobe RGB):
DSC0□□□□.ARW
 - RAW data file (Adobe RGB):
_DSC□□□□.ARW
- The extension may not be displayed depending on the computer.

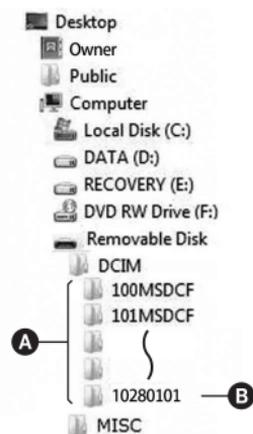

Copying images stored on a computer to a memory card and viewing the images

This section describes the process using a Windows computer as an example. Step 1 is not necessary if the file name has not been changed.

1 Right-click the image file, then click [Rename]. Change the file name to “DSC0□□□□.”

Enter a number from 0001 to 9999 for □□□□.

- If the overwrite confirmation message appears, enter a different number.
- An extension may be displayed depending on the computer settings. The extension for images is JPG. Do not change the extension.

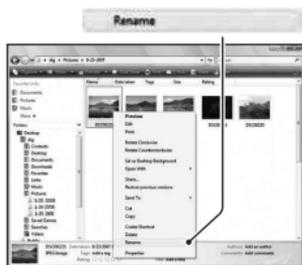

2 Copy the image file to the memory card folder in the following order.

- ① Right-click the image file, then click [Copy].
 - ② Double-click [Removable Disk] in [Computer] (For Windows XP: [My Computer]).
 - ③ Right-click the [□□□MSDCF] folder in the [DCIM] folder, then click [Paste].
- □□□ stands for any number within the range from 100 to 999.



Notes

- You may be unable to play back some images depending on the image size.
- When an image file has been processed by a computer or when the image file was recorded using a model other than that of your camera, playback on your camera is not guaranteed.
- When there is no folder, first create a folder with your camera (page 127) and then copy the image file.

Using the software

To utilize images recorded with the camera, the following software is provided:

- Sony Image Data Suite
 - “Image Data Converter SR”
 - “Image Data Lightbox SR”
 - “Remote Camera Control”
- Sony Picture Utility
 - “PMB” (Picture Motion Browser)

Note

- “PMB” is not compatible with Macintosh computers.

Recommended computer environment

■ Windows

Recommended environment for using “Image Data Converter SR Ver.3”/“Image Data Lightbox SR”/“Remote Camera Control”

OS (pre-installed): Microsoft Windows XP*¹ SP3/Windows Vista*² SP1

*1 64-bit editions and Starter (Edition) are not supported.

*2 Starter (Edition) is not supported.

CPU/Memory: Pentium 4 or faster is recommended, RAM 1 GB or more is recommended.

Display: 1024 × 768 dots or more

Recommended environment for using “PMB”

OS (pre-installed): Microsoft Windows XP*¹ SP3/Windows Vista*² SP1

*1 64-bit editions and Starter (Edition) are not supported.

*2 Starter (Edition) is not supported.

CPU/Memory: Pentium III 500 MHz or faster, 256 MB of RAM or more (Recommended: Pentium III 800 MHz or faster and 512 MB of RAM or more)

Hard Disk: Disk space required for installation—500 MB or more

Display: 1024 × 768 dots or more

■ Macintosh

Recommended environment for using “Image Data Converter SR Ver.3”/
“Image Data Lightbox SR”/“Remote Camera Control”

OS (pre-installed): Mac OS X (v10.4/v10.5)

CPU: Power PC G4/G5 series (1.0 GHz or faster is recommended)/Intel
Core Solo/Core Duo/Core 2 Duo or faster

Memory: 1 GB or more is recommended.

Display: 1024 × 768 dots or more

Installing the software

■ Windows

- Log on as Administrator.

1 Turn on your computer, and insert the CD-ROM (supplied) into the CD-ROM drive.

The installation menu screen appears.

- If it does not appear, double-click [Computer] (For Windows XP: [My Computer]) →  (SONYPICTUTIL) → [Install.exe].
- Under Windows Vista, the AutoPlay screen may appear. Select “Run Install.exe” and follow the instructions that appear on the screen to proceed with the installation.



2 Click [Install].

Verify that both “Sony Image Data Suite” and “Sony Picture Utility” are checked and follow the instructions on the screen.

3 Remove the CD-ROM after the installation is complete.

The following software is installed and shortcut icons appear on the desktop.

- Sony Image Data Suite
 - “Image Data Converter SR”
 - “Image Data Lightbox SR”
 - Sony Picture Utility
 - “PMB”
 - “PMB Guide”
-

■ Macintosh

- Log on as Administrator.
-

1 Turn on your Macintosh computer, and insert the CD-ROM (supplied) into the CD-ROM drive.

2 Double-click the CD-ROM icon.

3 Copy the [IDS_INST.pkg] file in the [MAC] folder to the hard disk icon.

4 Double-click the [IDS_INST.pkg] file in the copy-to folder.

Follow the instructions on the screen to complete the installation.

Note

- When the restarting confirmation message appears, restart the computer following the instructions on the screen.

Using “Image Data Converter SR”

Note

- If you save an image as RAW data, the image is saved in the ARW2.1 format.

With “Image Data Converter SR” you can:

- Edit images recorded in RAW format with various corrections, such as tone curve, and sharpness.
- Adjust images with the white balance, exposure, and creative style, etc.
- Save the images displayed and edited on a computer. You can either save the image as RAW format or save it in the general file format.
- For details on “Image Data Converter SR,” refer to the Help.

To start the Help, click [Start] → [All Programs] → [Sony Image Data Suite] → [Help] → [Image Data Converter SR Ver.3].

To start up/exit “Image Data Converter SR”

■ Windows

Double-click the shortcut of “Image Data Converter SR Ver.3” on the desktop.

When starting up from the Start menu, click [Start] → [All Programs] → [Sony Image Data Suite] → [Image Data Converter SR Ver.3].

To exit, click the  button on the upper-right corner of the screen.

■ Macintosh

Double-click [Image Data Converter SR Ver.3] in the [Sony Image Data Suite] folder from the [Application] folder.

To exit, click [Quit Image Data Converter SR] from the [IDC SR] menu.

Using “Image Data Lightbox SR”

With “Image Data Lightbox SR” you can:

- Display and compare RAW/JPEG images recorded with this camera.
- Rate the images on a scale of five.
- Set color labels and so on.
- Display an image in “Image Data Converter SR” and make adjustments to it.
- For details on “Image Data Lightbox SR,” refer to the Help.

To start the Help from the Start menu, click [Start] → [All Programs] → [Sony Image Data Suite] → [Help] → [Image Data Lightbox SR].

To start up/exit “Image Data Lightbox SR”

■ Windows

Double-click [Image Data Lightbox SR] on the desktop.

When starting up from the Start menu, click [Start] → [All Programs] → [Sony Image Data Suite] → [Image Data Lightbox SR].

To exit, click the  button on the upper-right corner of the screen.

The dialogue used for saving a collection appears.

■ Macintosh

Double-click [Image Data Lightbox SR] in the [Sony Image Data Suite] folder from the [Application] folder.

To exit, click [Quit Image Data Lightbox SR] from the [Image Data Lightbox SR] menu.

Using the “Remote Camera Control”

Connect the camera to your computer. With “Remote Camera Control” you can:

- Set up the camera or record an image from the computer.
- Record an image directly to the computer.
- Perform an Interval Timer Shooting (Only for Windows).

To start the Help from the Start menu, click [Start] → [All Programs] → [Sony Image Data Suite] → [Help] → [Remote Camera Control].

1 Press the MENU button, and set [USB connection] to [Remote PC] in the  Setup menu 2 with /// on the multi-selector.

2 Connect the camera and your computer.

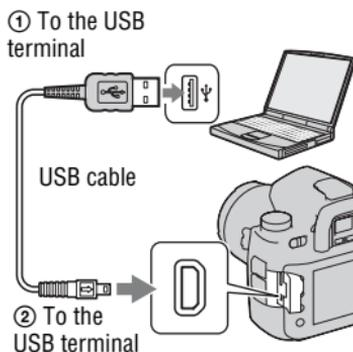

3 Turn on the camera and the computer, then start the “Remote Camera Control.”

Notes

- When you press the shutter button without looking into the viewfinder, close the eyepiece shutter with the eyepiece shutter lever.
- In Interval Timer Shooting, the drive mode is set to (Single-shot adv.). If the focus is not achieved, the shutter is not released (except when the manual focus is selected or [Priority setup] in the Recording menu is set to [Release]).

To start up/exit “Remote Camera Control”

■ Windows

Click [Start] → [All Programs] → [Sony Image Data Suite] → [Remote Camera Control].

To exit, click the button on the upper-right corner of the screen.

■ Macintosh

Double-click [Remote Camera Control] in the [Sony Image Data Suite] folder from the [Application] folder.

To exit, click [Quit Remote Camera Control] from the [Remote Camera Control] menu.

Using “PMB”

Note

- “PMB” is not compatible with Macintosh computers.

With “PMB” you can:

- Import images shot with the camera and display them on the computer.
- Organize images on the computer on a calendar by shooting date to view them.
- Retouch (Red Eye Correction, etc.), print, and send still images as e-mail attachments, change the shooting date and more.
- Print or save still images with the date.
- Create a data disc using a CD burner drive or DVD burner drive.
- For details on “PMB,” refer to “PMB Guide.”

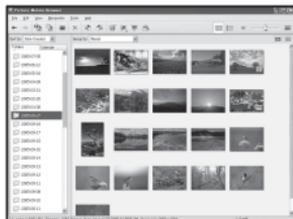

To start “PMB Guide,” double-click the shortcut of  (PMB Guide) on the desktop. When starting up from the start menu, click [Start] → [All Programs] → [Sony Picture Utility] → [Help] → [PMB Guide].

To start up/exit “PMB”

Double-click the  (PMB) icon on the desktop.

Or, from the Start menu: Click [Start] → [All Programs] → [Sony Picture Utility] → [PMB].

To exit the “PMB,” click  button on the upper-right corner of the screen.

Note

- The confirmation message of the Information tool appears on the screen when starting “PMB” for the first time. Select [Start]. This function informs you of news, such as software updates. You can change the setting later.

Printing images by connecting the camera to a PictBridge compliant printer

Even if you do not have a computer, you can print images shot using your camera by connecting the camera directly to a PictBridge compliant printer.

“PictBridge” is based on the CIPA standard. (CIPA: Camera & Imaging Products Association)



Note

- You cannot print RAW images.

Stage 1: Setting the camera

Note

- It is recommended to use the AC Adaptor/charger (sold separately) to prevent the power from turning off partway through printing.

1 Press the MENU button, and set [USB connection] to [PTP] in the  Setup menu 2 with  on the multi-selector.

2 Turn the camera off and insert the memory card that the images have been recorded on.

Stage 2: Connecting the camera to the printer

1 Connect the camera to the printer.

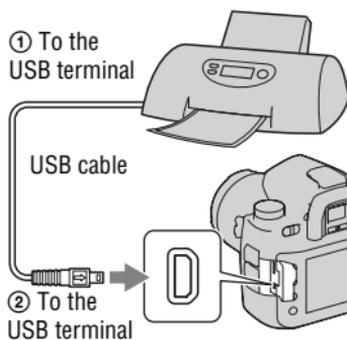

2 Turn on your camera and the printer.

The screen used for selecting images you want to print appears.

Stage 3: Printing

1 Select the image to print with ◀/▶ on the multi-selector, then press the center of the multi-selector.

- To cancel, press the center again.

2 Repeat step 1 if you want to print other images.

3 Press the MENU button and set up each item.

- For details on setting items, see “PictBridge menu.”

4 Select [Print] → [OK] in the menu, then press the center of the multi-selector.

The image is printed.

- After the screen indicating that the print is completed appears, press the center of the multi-selector.

To cancel the print

During printing, pressing the center of the multi-selector cancels the print. Remove the USB cable or turn off the camera. When you want to print again, follow the procedure (Stages 1 to 3) above.

PictBridge menu

Page 1

Print

Prints the selected images. For details, see "Stage 3: Printing."

Set print q'ty

You can specify the number of prints, up to 20. The same number of prints is specified on all the selected images.

Paper size

Auto	Printer setup
9×13cm/3.5"×5"	89×127 mm
Hagaki	100×147 mm
10×15cm	10×15 cm
4"×6"	101.6×152.4 mm
A6/4.1"×5.8"	105×148.5 mm
13×18cm/5"×7"	127×178 mm
Letter	216×279.4 mm
A4/8.3"×11.7"	210×297 mm
A3/11.7"×16.5"	297×420 mm
Wide/4"×7.1"	10.2×18.1 cm
A3+/13"×19"	329×483 mm

Layout

Auto	Printer setup
1-up/Borderless	Borderless, 1 image/sheet
1-up	1 image/sheet
2-up	2 images/sheet
3-up	3 images/sheet
4-up	4 images/sheet
8-up	8 images/sheet
Index	Prints all the selected images as an index print. Printing layout follows the printer setup.

Date imprint

Day and time	Attaches the date and time.
Date	Attaches the date.
Off	Does not attach the date.

Page 2

Unmark all

After the message appears, select [OK], then press the center of the multi-selector. The  mark on each image is cleared. When you cancel your specification without printing images, select this item.

Folder print

Prints all the images in a memory card. After the message appears, select [OK], then press the center of the multi-selector.

Specifications

Camera

[System]

Camera Type	Digital Single Lens Reflex Camera and interchangeable lenses
Lens	All of α Lens (except for DT lens*)

* Using a DT lens is not guaranteed because the corners of the field are darkened and the camera does not meet the primary AE performance standard. [APS-C size capt.] is automatically selected.

[Image sensor]

Total pixel number of camera	Approx. 25 720 000 pixels
Effective pixel number of camera	Approx. 24 610 000 pixels
Image format	35 mm (35.9×24.0) CMOS sensor

[SteadyShot]

System	Sensor-Shift mechanism
SteadyShot Compensation capability	Approximately 2.5 to 4 EV decrease in shutter speed (varies according to shooting conditions and lens used)

[Anti-Dust]

System	Charge protection coating on Low-Pass Filter and image sensor-Shift mechanism
--------	---

[Viewfinder]

Type	Fixed eye-level system with pentaprism
Focusing Screen	Spherical Acute Matte (exchangeable, option)
Frame coverage	Approx. 0.98
Magnification	0.74 × with 50 mm lens at infinity, -1 m^{-1}
Eye point	Approximately 20 mm from the eyepiece
Diopter Adjustment	-3.0 to $+1.0 \text{ m}^{-1}$

[Auto Focus System]

System	TTL phase-detection system, CCD line sensors (with center dual cross-hair sensor, F2.8 sensor)
Ranging point	9 points and 10 supplementary ranging points
Sensitivity Range	0 to 18 EV (at ISO 100 equivalent)
AF illuminator	Approx. 1 to 7 m (3.3 to 23 feet)

[Exposure]

Metering Cell	40-segment honeycomb-pattern SPC
Metering Range	0 to 20 EV (2 to 20 EV with Spot metering), (at ISO 100 with F1.4 lens)
ISO sensitivity (Recommended exposure index)	AUTO, 100 to 6400

[Shutter]

Type	Electronically-controlled, vertical-traverse, focal-plane type
Speed range	1/8000 second to 30 seconds, bulb
Flash sync speed	1/250 second (SteadyShot deactivated), 1/200 second (SteadyShot activated)

[Recording media]

CompactFlash card (Type I, II), Microdrive, "Memory Stick Duo" media

[LCD monitor]

LCD panel	7.5 cm (3.0 type) TFT drive
Total number of dots	921 600 (640 × 3 (RGB) × 480) dots

[LCD monitor]

With backlighting

[Power, general]

Used battery pack	Rechargeable battery pack NP-FM500H
-------------------	-------------------------------------

[Others]

PictBridge	Compatible
Exif Print	Compatible
PRINT Image Matching III	Compatible
Dimensions	Approx. 156.3 × 116.9 × 81.9 mm (6 1/4 × 4 5/8 × 3 1/4 inches) (W/H/D, excluding protrusions)

Mass	Approx. 850 g (1 lb 14 oz) (without batteries, memory card and body accessories)
Operating temperature	0 to 40°C (32 to 104°F) (When using the Microdrive: 5 to 40°C (41 to 104°F))
Exif	Exif Ver.2.21
USB communication	Hi-Speed USB (USB 2.0 compliant)

BC-VM10 Battery charger

Input rating	100 V – 240 V AC, 50/60 Hz
Output rating	8.4 V DC, 750 mA
Operating temperature range	0 to 40°C (32 to 104°F)
Storage temperature range	–20 to +60°C (–4 to +140°F)
Maximum dimensions	Approx. 70 × 25 × 95 mm (2 7/8 × 1 × 3 3/4 inches) (W/H/D)
Mass	Approx. 90 g (3.2 oz)

Rechargeable battery pack NP-FM500H

Used battery	Lithium-ion battery
Maximum voltage	DC 8.4 V
Nominal voltage	DC 7.2 V
Maximum charge current	2.0 A

Maximum charge voltage
DC 8.4 V

Capacity

Typical 11.8 Wh (1 650 mAh)

Minimum 11.5 Wh (1 600 mAh)

Maximum dimensions

Approx. 38.2 × 20.5 × 55.6
mm (1 9/16 × 13/16 × 2 1/4
inches) (W/H/D)

Mass Approx. 78 g (2.8 oz)

Design and specifications are subject
to change without notice.

On image data compatibility

- This camera conforms with DCF (Design rule for Camera File system) universal standard established by JEITA (Japan Electronics and Information Technology Industries Association).
- Playback of images recorded with your camera on other equipment and playback of images recorded or edited with other equipment on your camera are not guaranteed.

Trademarks

- **α** is a trademark of Sony Corporation.
- “Memory Stick,” , “Memory Stick PRO,” **MEMORY STICK PRO**, “Memory Stick Duo,” **MEMORY STICK DUO**, “Memory Stick PRO Duo,” **MEMORY STICK PRO DUO**, “Memory Stick PRO-HG Duo,” **MEMORY STICK PRO-HG DUO**, “Memory Stick Micro,” “MagicGate,” and **MAGICGATE** are trademarks of Sony Corporation.
- “InfoLITHIUM” is a trademark of Sony Corporation.

- “PhotoTV HD” is a trademark of Sony Corporation.
- Microsoft, Windows, and Windows Vista are either registered trademarks or trademarks of Microsoft Corporation in the United States and/or other countries.
- HDMI, the HDMI logo and High-Definition Multimedia Interface are trademarks or registered trademarks of HDMI Licensing LLC.
- Macintosh, Mac OS, iMac, iBook, PowerBook, Power Mac, and eMac are trademarks or registered trademarks of Apple Inc.
- Intel, Intel Core, MMX, and Pentium are trademarks or registered trademarks of Intel Corporation.
- CompactFlash is a trademark of SanDisk Corporation.
- Microdrive is a registered trademark of Hitachi Global Storage Technologies in the United States and/or other countries.
- Adobe is a registered trademark or a trademark of Adobe Systems Incorporated in the United States and/or other countries.
- D-Range Optimizer Advanced uses technology provided by  Apical Limited.
- In addition, system and product names used in this manual are, in general, trademarks or registered trademarks of their respective developers or manufacturers. However, the TM or ® marks are not used in all cases in this manual.

Troubleshooting

If you experience trouble with your camera, try the following solutions. Check the items on pages 157 to 163. Consult your Sony dealer or local authorized Sony service facility.

❶ Check the following items.

❷ Remove the battery pack, and insert the battery pack again after about one minute, and turn on the power.

❸ Reset the settings (page 132).

❹ Consult your Sony dealer or local authorized Sony service facility.

Battery pack and power

The battery remaining indicator is incorrect, or sufficient battery remaining indicator is displayed but the power runs out too quickly.

- This phenomenon occurs when you use the camera in an extremely hot or cold location (page 167).
- The displayed battery remaining differs from the current one. Fully discharge and then charge the battery pack to correct the display.
- The battery pack is discharged. Install a charged battery pack (page 18).
- The battery pack is dead (page 20). Replace it with new one.

The power turns off suddenly.

- If you do not operate the camera for given period of time, the camera turns to power saving mode and nearly shuts down. To cancel the power save, operate the camera, such as pressing the shutter button halfway down (page 124).

Shooting images

Nothing is displayed on the LCD monitor when the power is turned on.

- In the default setting, the LCD monitor will turn off if no operation is registered for more than five seconds to minimize the battery consumption. You can change the time that the LCD monitor is turned off (page 124).
- The LCD monitor is set to off. Press the DISP button to turn the LCD monitor on (page 40).

The image is not clear in the viewfinder.

- Adjust the diopter scale properly using the diopter-adjustment dial (page 28).

The shutter does not release.

- Check the free capacity of the memory card (page 31). If it is full, do one of the following:
 - Delete unnecessary images (page 97).
 - Change the memory card.
- The shutter cannot be released when the subject is out of focus (page 109).
- When an astronomical telescope, etc., is attached to the camera, set the exposure mode to M and do your shooting.

Recording takes a long time.

- The noise reduction function is turned on (page 110). This is not a malfunction.
- You are shooting in RAW mode (page 105). Since the RAW image is large, the RAW mode shooting may take time.

The date and time are recorded incorrectly.

- Set the correct date and time (pages 27, 125).

The aperture value and/or shutter speed flash when you press the shutter button halfway down.

- Since the subject is too bright or too dark, it is beyond the available range of the camera. Adjust the setting again.

The image is whitish (Flare).**Blurring of light appears on the image (Ghosting).**

- The picture was taken under a strong light source, and excessive light has entered the lens. Attach a lens hood.

The corners of the picture are too dark.

- If any filter or hood is used, take it off and try shooting again. Depending on the thickness of the filter and improper attachment of the hood, the filter or the hood may partially appear in the image. The optical properties of some lenses may cause the periphery of the image to appear too dark (insufficient light). In such cases, making the aperture smaller by 1 to 2 steps may prevent this phenomenon.

Dots appear and remain on the LCD monitor.

- This is not a malfunction. These dots are not recorded (page 9).

The EV scale ◀ ▶ is flashing in the viewfinder.

- The subject is too bright or too dark for the metering range of the camera.

Viewing images

Your camera cannot play back images.

- The folder/file name has been changed on your computer (page 141).
- When an image file has been processed by a computer or when the image file was recorded using a model other than that of your camera, playback on your camera is not guaranteed.
- The camera is in USB mode. Delete the USB connection (page 139).

The image does not appear on the TV screen.

- Check [Video output] to see if the video output signal of your camera is set to the color system of your TV (page 100).
- Check whether the connection is correct (page 99).

Deleting/Editing images

Your camera cannot delete an image.

- Cancel the protection (page 121).

Computers

Your computer does not recognize your camera.

- Use the USB cable (supplied) (page 136).
 - Disconnect the USB cable, and connect it again firmly.
 - Set [USB connection] to [Mass Storage] (page 136).
 - Disconnect all equipment other than the camera, the keyboard and the mouse from the USB jacks of your computer.
-

You cannot copy images.

- When you are copying images from the camera to your computer, if you open the memory card cover, the copy is canceled. Do not open the memory card cover during copying.
- When you shoot images with a memory card formatted by a computer, you may not be able to copy the images to a computer. Shoot using a memory card formatted by your camera (page 120).

Memory card

Cannot insert a memory card.

- Insertion direction of the memory card is wrong. Insert it in the correct direction (page 23).
-

Cannot record on a memory card.

- The memory card is full. Delete unnecessary images (page 97).
 - An unusable memory card is inserted (page 23).
-

You have formatted a memory card by mistake.

- All the data on the memory card is deleted by formatting. You cannot restore it.

Printing

Also see “PictBridge compliant printer” (as follows) in conjunction with the following items.

The color of the image is strange.

- When you print the images recorded in Adobe RGB mode using sRGB printers that are not compatible with Adobe RGB (DCF2.0/Exif2.21), the images are printed at a lower intensity level (page 106).

Images are printed with both edges cut off.

- Depending on your printer, the left, right, top, and bottom edges of the image may be cut off. Especially when you print an image shot with the aspect ratio set to [16:9], the lateral end of the image may be cut off.
- When printing images using your own printer, cancel the trimming or borderless settings. Consult the printer manufacturer as to whether the printer provides these functions or not.

Cannot print images with the date.

- Using “PMB,” you can print images with date (page 149).
- This camera does not have a feature for superimposing dates on images. However, because the images shot with the camera include information on the recording date, you can print images with the date superimposed if the printer or the software can recognize Exif information. For compatibility with Exif information, consult the manufacturer of the printer or the software.
- When you print images at a shop, images can be printed with the date if you ask them to do so.

PictBridge compliant printer

For details, refer to the operating instructions supplied with the printer or consult with the manufacturer of the printer.

A connection cannot be established.

- The camera cannot be connected directly to a printer that is not compliant with the PictBridge standard. Consult the printer manufacturer as to whether the printer is compliant with PictBridge or not.
- Set [USB connection] to [PTP] (page 150).

- Disconnect and connect the USB cable again. If an error message is indicated on the printer, refer to the operating instructions supplied with the printer.

Cannot print images.

- RAW images cannot be printed.
- Images shot using cameras other than this camera or images modified with a computer may not be printed.

“---- -- --” is printed on the date-inserted part of the image.

- Images that do not have the recording data cannot be printed with the date inserted. Set [Date imprint] to [Off] and print the image again (page 153).

Others

The message “Set date and time?” appears when you turn on the camera.

- The camera has been left unused for sometime with a low battery or no battery pack. Charge the battery pack and set the date again (page 27). If the date setting is lost every time the battery pack is charged, consult your Sony dealer or local authorized Sony service facility.

The number of recordable images does not decrease or decreases two at a time.

- This is because the compression rate and the image size after compression change depending on the image when you shoot a JPEG image (page 105).

The setting is reset without the resetting operation.

- The battery pack was removed when the power switch was set to ON. When removing the battery pack, make sure the camera is turned off and the access lamp is not illuminated (page 18).

The camera does not work properly.

- Turn off the camera. Remove the battery pack and insert it again. If an AC Adaptor/charger (sold separately) is used, disconnect the power cord. If the camera is hot, allow it to cool down before trying this corrective procedure. If the camera does not work after doing these solutions, consult your Sony dealer or local authorized Sony service facility.

The five bars of the SteadyShot scale flash on the lower-right corner of the viewfinder.

- The SteadyShot function does not work. You can continue to shoot but the SteadyShot function will not work. Turn the camera off and on. If the SteadyShot scale continues to flash, consult your Sony dealer or local authorized Sony service facility.

“--E-” is indicated on the lower-right corner of the LCD monitor.

- Remove the memory card, and insert it again. If this procedure does not turn off the indication, format the memory card.

Warning messages

If the following messages appear, follow the instructions.

For “InfoLITHIUM” battery only

- An incompatible battery pack is being used.

Set date and time?

- Set the date and time. If you have not used the camera for a long time, charge the internal rechargeable battery (pages 27, 167).

Power insufficient

- You tried to perform [Cleaning mode] when the battery level is insufficient. Charge the battery pack or use the AC Adaptor/charger (sold separately).

No Memory Stick No CF card

- The type of the memory card inserted into the camera is different from the memory card type selected with [Memory card] in the  Setup menu. Set it to appropriate position.

Unable to use Memory Stick. Format?

Unable to use CF card. Format?

- The memory card was formatted on a computer and the file format was modified, or the memory card

was formatted on another device. Select [OK], then format the memory card. You can use the memory card again, however, all previous data in the memory card is erased. It may take a some time to complete the format.

If the message still appears, change the memory card.

Card error

- An incompatible memory card is inserted or the format was failed.

Read only memory

- Your camera cannot record or delete images on these “Memory Stick Duo” media.

Reinsert the Memory Stick. Reinsert the CF card.

- The inserted memory card cannot be used in your camera.
- The memory card is damaged.
- The terminal section of the memory card is dirty.

Processing... Unable to operate.

- When the buffer memory is full, you attempt to operate the Intelligent preview function by releasing the preview button.

Invalid operation

- When in BULB shooting, you attempt to operate the Intelligent preview function.

Use Memory Stick slot to format.

- You attempt to format the “Memory Stick Duo” media that is inserted into the CF card insertion slot using an adaptor. Insert the “Memory Stick Duo” media into the “Memory Stick Duo” media insertion slot and format it.

No Memory Stick inserted. Shutter is locked.**No CF card inserted. Shutter is locked.**

- [Release w/oCard] is set to [Disable]. Set it to [Enable] or insert a memory card.

Unable to display.

- Images recorded with other cameras or images modified with a computer may not be able to be displayed.

No lens attached. Shutter is locked.

- The lens is not attached properly, or the lens is not attached.
- When attaching the camera to an astronomical telescope or something similar, set the exposure mode to M.

Unable to print.

- You tried to mark RAW images with a DPOF mark.

Check the connected device.

- A connection cannot be established. Disconnect the USB cable and connect it again.

Camera overheating. Allow it to cool.

- The camera has become hot because you have been shooting continuously. Turn the power off. Cool the camera and wait until the camera is ready to shoot again.

**Camera error
System error**

- Turn the power off, remove the battery pack, then re-insert it. If the message appears frequently, consult your Sony dealer or local authorized Sony service facility.

Cover open

- Close the memory card cover to start shooting.

**Unable to magnify.
Unable to rotate image.**

- Images recorded with other cameras may not be enlarged or rotated.

No images changed

- You attempted to protect images or specified DPOF without changing the specification of those images.

Cannot create more folders.

- The folder with a name beginning with “999” exists on the memory card. You cannot create any folders if this is the case.

Printing canceled

- The print job was canceled. Disconnect the USB cable or turn the camera off.

Unable to mark.

- You attempted to mark RAW images on the PictBridge screen.

Printer error

- Check the printer.
- Check if the image you want to print is corrupted.

Printer busy

- Check the printer.

Precautions

Do not use/store the camera in the following places

- In an extremely hot, dry or humid place
In places such as in a car parked in the sun, the camera body may become deformed and this may cause a malfunction.
- Under direct sunlight or near a heater
The camera body may become discolored or deformed, and this may cause a malfunction.
- In a location subject to rocking vibration
- Near strong magnetic place
- In sandy or dusty places
Be careful not to let sand or dust get into the camera. This may cause the camera to malfunction, and in some cases this malfunction cannot be repaired.

On carrying

- Be sure to attach the lens cap or body cap when not using the camera. When attaching the body cap, remove all the dust from the cap before placing it on the camera.

On operating temperatures

Your camera is designed for use under the temperatures between 0 and 40°C (32 and 104°F) (When using a Microdrive: 5 and 40°C (41 and 104°F)). Shooting in extremely cold

or hot places that exceed this range is not recommended.

On moisture condensation

If the camera is brought directly from a cold to a warm location, moisture may condense inside or outside the camera. This moisture condensation may cause a malfunction of the camera.

How to prevent moisture condensation

When bringing the camera from a cold place to a warm place, seal the camera in a plastic bag and allow it to adapt to conditions at the new location over about an hour.

If moisture condensation occurs

Turn off the camera and wait about an hour for the moisture to evaporate. Note that if you attempt to shoot with moisture remaining inside the lens, you will be unable to record clear images.

On the internal rechargeable battery

This camera has an internal rechargeable battery for maintaining the date and time and other settings regardless of whether the power is on or off.

This rechargeable battery is continually charged as long as you are using the camera. However, if you use the camera for only short periods, it discharges gradually, and if you do not use the camera at all for about 8 months it becomes completely

discharged. In this case, be sure to charge this rechargeable battery before using the camera.

However, even if this rechargeable battery is not charged, you can still use the camera as long as you do not record the date and time. If the camera resets the settings to the defaults each time you charge the internal rechargeable battery, the battery may be dead. Consult your Sony dealer or local authorized Sony service facility.

Charging method of the internal rechargeable battery

Insert a charged battery pack in the camera, or connect the camera to a wall outlet (wall socket) using the AC Adaptor/charger (sold separately), and leave the camera for 24 hours or more with the power off.

Notes on recording/playback

- Before you record one-time events, make a trial recording to make sure that the camera is working correctly.
- This camera is designed to be dust- and moisture-resistant but not to be waterproof and splash-proof. When using the camera in the rain, be careful not to get the camera and lens wet. Clean the camera after use if the camera becomes dirty. With water, sand, dust, salt, etc., left on the camera, the camera may cause a malfunction.
- Do not look at the sun or a strong light through a removed lens or the viewfinder. This may cause

irrecoverable damage to your eyes. Or it may cause a malfunction of your camera.

- Do not use the camera near a location that generates strong radio waves or emits radiation. The camera may not be able to record or play back properly.
- Using the camera in sandy or dusty locations may cause malfunctions.
- If moisture condensation occurs, remove it before using the camera (page 167).
- Do not shake or strike the camera. In addition to malfunctions and an inability to record images, this may render the memory card unusable, or cause image data breakdown, damage or loss.
- Keep the camera, supplied accessories, etc., out of the reach of children. The “Memory Stick Duo” media, etc., may be swallowed. If such a problem occurs, consult a doctor immediately.

Notes on handling the focusing screen

- Be careful not to touch the focusing screen, the mirror, etc., with your finger.
- If dust lands on the surface of the screen, remove dust using a blower. In this case, do not use a spray blower.
- If the screen has a scratch or gets oily, consult your Sony dealer or local authorized Sony service facility.

Index

Numerics

40-segment honeycomb pattern
metering 67

A

Adobe RGB..... 106
AE lock 69
AEL button 115
AF area..... 58
AF illuminator..... 60
AF Micro Adj..... 130
AF/MF control 62
Ambient light 69
Anti-dust function 34
Aperture 51
APS-C size 132
Aspect ratio 104
Audio signals 129
Auto focus..... 56
Auto review..... 114
Autoflash..... 64

B

Battery pack 18
Bracket 83
Bright area portion 91
BULB shooting 54

C

C button..... 106

Center weighted 67
CF card..... 23
Charging battery pack 14
Cleaning mode 34
Color filter..... 74
Color Space 106
Color temperature 74
Compression ratio 105
Continuous AF 56
Continuous bracket 83
Continuous shooting 81, 82
Contrast 78
Creative Style..... 78
Custom button..... 106
Custom white balance 75

D

Dark area portion 91
Date imprint 122
Date/Time setup 27
Delete 97
Diopter-adjustment..... 28
Direct manual focus 61
DISP button..... 40, 90
Display panel..... 42
DPOF setup 121
D-Range Optimizer 77
DRIVE button 81
Drive mode..... 81

E

Enlarged screen	93
EV scale	53, 70, 84
Exposure compensation	68
Exposure lock	69
Exposure mode	49
Eye cup	28

F

File number	126
Flash	63
Flash compensation	71
Flash control	107
Flash mode	64
Fn button	46
Focus	56
Focus indicator	57
Focusing Screen	131
Focus-lock	59
Folder name	126
Format	120

H

HDMI output	101
High ISO NR	110
High Speed Sync	65
Histogram	91, 96

I

Image Data Converter SR	146
Image Data Lightbox SR	146
Image quality	105

Image size	104
Index print	122
Index screen	94
Info.disp.time	124
Intelligent preview	87
ISO Auto Range	108
ISO sensitivity	72

J

JPEG	105
------------	-----

L

LCD brightness	124
LCD monitor	39, 95
Lens	21
Long exp.NR	110

M

Manual exposure	53
Manual focus	60
Manual shift	54
Memory	89
“Memory Stick Duo”	23
MENU button	102
Menu list	102
Metering mode	67
Microdrive	23
Mirror lockup	81, 85
Moisture condensation	167
Multi segment	67
Multi-selector	45

N

- New folder 127
- Noise reduction 110
- Number of recordable images
..... 19, 31

P

- PictBridge 150
- PlaybackDisplay 122
- PMB 149
- Power save 124
- Preset white balance..... 73
- Pressing halfway down 47, 110
- Preview 87
- Print..... 121, 150
- Priority setup..... 109
- Program auto..... 49
- Program Shift..... 50
- Protect 121

Q

- Quick Navi 46

R

- RAW 105, 146
- Rear sync..... 64
- Rec mode reset..... 111
- Rec.info.disp. 117
- Remote Camera Control 147
- Remote Commander 81, 86
- Reset..... 111, 119, 132
- Reset default 132
- Rotate 92

S

- Saturation 78
- Select folder 127
- Self-timer 83
- Set the clock..... 27
- Sharpness 78
- Shooting 47
- Shoulder strap 29
- Shutter speed..... 49, 52
- Single bracket..... 83
- Single-shot AF 56
- Slide show 123
- Slow sync 65
- Specifications 154
- Spot 67
- sRGB 106
- SteadyShot function 44

U

- USB connection 127

V

- Video output..... 125
- Viewfinder 28, 43
- Viewing image 90, 99

W

- WB button 73
- White balance..... 73
- White balance bracket 85
- Wireless flash..... 64